



DR. FISCHER
Group

Catalogue Infrared Halogen Lamps



Flash me



EMEA

Germany, Austria, Switzerland & Eastern Europe

Sales Manager

Tel. +49 (0) 6432 9131-33

Fax +49 (0) 6432 9131-73

diez.sales@dr-fischer-group.com

Order Desk

Tel. +49 (0) 6432 9131-80

Fax +49 (0) 6432 9131-73

diez.orderdesk@dr-fischer-group.com

Others EMEA countries

Sales Manager

Tel. +33 (0) 3 83 80 30 60

Fax +33 (0) 3 83 80 30 48

info.europe@dr-fischer-group.com

Order Desk

Tel. +33 (0) 3 83 80 30 60

Fax +33 (0) 3 83 80 30 48

pam.orderdesk@dr-fischer-group.com

AMERICAS

Sales Manager

Tel. +33 (0) 3 83 80 30 21

Fax +33 (0) 3 83 80 30 48

northam.sales@dr-fischer-group.com

Order Desk

Tel. +33 (0) 3 83 80 30 60

Fax +33 (0) 3 83 80 30 48

pam.orderdesk@dr-fischer-group.com

ASIA & PACIFIC REGION

Sales Manager

Tel. +82 70 8666 1637

Fax +82 2 927 3488

info.apr@dr-fischer-group.com

Order Desk

Tel. +33 (0) 3 83 80 30 60

Fax +33 (0) 3 83 80 30 48

pam.orderdesk@dr-fischer-group.com

DR. FISCHER Europe S.A.S.
Zone industrielle de Montrichard
BP 80149
54705 Pont-à-Mousson CEDEX
FRANCE

Tel. +33 (0) 3 83 80 30 60

Fax +33 (0) 3 83 80 30 48

Internet: *www.dr-fischer-group.com*

Printing date : August 2014

All technical data, dimensions and illustrations are non-binding.

We reserve the right to make alterations in construction. We assume no liability for printing errors.

The general sales conditions of DR. FISCHER Europe S.A.S. apply.

Design: Figures Imposées, *www.figimp.com*

Introduction

Contacts	2
DR. FISCHER Group	4
DR. FISCHER Europe S.A.S.	5
Location	6
Information about infrared	7

Industrial solutions

9

DR. FISCHER infrared halogen lamps for Industrial applications	10
Overview of caps and terminals	11
Short waves	
Clear lamps	12
Translucent / Gold-coated lamps	14
Double-sleeve / PAR38 lamps	15
White Integrated Reflector lamps	16
New White Integrated Reflector lamps - LRI	18
Proximity Reflector lamps - LRPTM	19
Fast medium waves	
Clear / Translucent lamps	20
White Integrated Reflector lamps / LRPTM	21

Comfort Heating solutions

22

DR. FISCHER infrared halogen lamps for Comfort Heating	23
Overview of caps and terminals	23
Garneta™ lamps	24
HeLeN™ lamps	25
Lucia™ lamps	27

Healthcare solutions

28

DR. FISCHER infrared halogen lamps for Healthcare	29
Overview of caps and terminals	29
Vitae™ lamps	30

Systems & Technical support

31

DR. FISCHER & You: an efficient partnership for improving your performance.....	32
Accessories	34
Symbols & Integration rules	36

The DR. FISCHER Group - Competence, Innovation, Service

The DR. FISCHER Group is one of the international leading providers of lamps and lights. The various companies of the Group complement each other with their individual specializations and together form a competent, innovative and fair partner for customers worldwide. The group employs more than 550 people in Europe.

The DR. FISCHER Group started 20 years ago as the result of the merge of three family companies : DR. FISCHER Speziallampenfabrik GmbH, Kegler Lichttechnik GmbH and Kandem Leuchten GmbH. Each individual company, with their specific fields, is a perfect complement to the others. This makes it possible to fulfill customer's wishes and requirements precisely, quickly and in a solution-oriented way. The greatest strengths of the group is

in offering tailor-made special applications and specific allround solutions.

The product portfolio includes signal lamps for streets, railways, air and waterways; special lamps for medicine and research; household lamps for ovens, extractor hoods and refrigerators; ultra violet (UV) medium pressure lamps for printing, drying; infrared halogen lamps and solutions for heating and warming; LED based lighting solutions.

More information:
www.dr-fischer-group.com



DR. FISCHER
Speziallampenfabrik GmbH

Ein Unternehmen der Dr. Fischer Gruppe



DR. FISCHER
Speziallampen Vertriebs GmbH

Ein Unternehmen der Dr. Fischer Gruppe



DR. FISCHER
Europe s.a.s.

A company of Dr. Fischer Group



DR. FISCHER
Italy s.r.l.

A company of Dr. Fischer Group



KEGLER
Lichttechnik GmbH

Ein Unternehmen der Dr. Fischer Gruppe



KANDEM
Leuchten GmbH

Ein Unternehmen der Dr. Fischer Gruppe



DR. FISCHER
LED GmbH

Ein Unternehmen der Dr. Fischer Gruppe



We are certified for quality and environmental management.



Pont-à-Mousson (France) is the headquarters of DR. FISCHER Europe S.A.S., the R&D and production center of infrared halogen, UV medium pressure and high-voltage lamps.



The headquarter of the complete DR. FISCHER Group is located in Diez, Germany. This is the main production center for Kandem Luminaires, LED Solutions and low-voltage lamps.



DR. FISCHER Italy s.r.l., in Alpiignano, produces special lamps for the domestic field.

The Pont-à-Mousson factory: a wealth of experience in lamp production

The manufacturing of lamps started in 1886 in Pagny-sur-Moselle, France with Fabius Henrion launching the first production of incandescent lamps.

In 1981, Philips built a new factory in Pont-à-Mousson (10 km away) which became "Philips Eclairage" in 1985.

In 1989, the assembly of infrared halogen lamps began in Pont-à-Mousson in a new dedicated area. From this time, Philips Eclairage started developing innovative products like the internationally famous HeLeN™ range.

In 2010, the DR. FISCHER Group took over the complete site of Philips Pont-à-Mousson. By this acquisition, the company strengthened its halogen production with high-speed machines. It now offers one of the biggest infrared portfolios with marketing/sales and distribution services. This means that the biggest centre of competence and production for infrared halogen lamps and solutions is located in France, between Metz and Nancy.

DR. FISCHER Europe S.A.S. has comprehensive competence for special infrared halogen solutions - engineering, modeli-

zation and testing laboratory, quality assurance production, marketing and sales. This unique synergy of the latest technology, experienced and motivated employees, tried and trusted procedures, flexibility and many years of experience in creating specific solutions together with the customer makes us the ideal partner in seeking future applications and solutions.

More information:

www.dr-fischer-group.com



The ISO certificates show the quality.



Our values:

- Strongly supporting our customers with customized and innovative solutions or systems
- Providing high quality products made in France

Our commitment:

- Fulfilling our customers with the best solutions
- Offering a reliable after-sales service



Location

Visit us:

Pont-à-Mousson is located in the East of France. Find useful hints for coming by:

Road:

- A31 Highway:
Luxembourg - Metz - Nancy - Lyon

Train:

- Roissy Charles de Gaulle TGV (High-speed train) - Lorraine TGV (1:20)
- Paris EST - Metz (1:40)

Airports:

- Metz-Nancy-Lorraine Regional Airport (20 min)
- Luxembourg and Saarbrücken International Airports (1:20)
- Roissy Charles de Gaulle (CDG) Airport / Orly Airport (3:00)
- Frankfurt Airport (2:45)



DR. FISCHER infrared solutions

Numerous manufacturing processes require heat: heating, drying, evaporating, shaping, gel formation, softening, tempering, adhering, activating, baking, laminating, disinfecting, conserving...





Industrial post-production processes undergo permanent rationalisation. The degree of automation is constantly increasing like production figures. Innovative, effective and cost-reducing solutions are necessary to survive in the current competitive atmosphere.

Infrared Heating principles

Basically there are three main heating principles:

- **Conduction:** heat transfer by direct contact between the source and the object.
- **Convection:** heat transfer by a flow of liquid or gas which is itself heated by a heat source.
- **Radiation:** heat transfer by the emission of radiation from a hotter object such as the sun, an open fire or an infrared lamp to its cooler surrounding environment. Objects which receive this radiation from the heat source absorb it and become warmer.

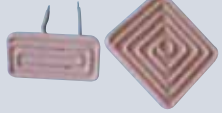
Emitters technology comparison

Emitter	Halogen lamp	Quartz emitter	Ceramic resistance	Gas burner
Illustration				
Infrared waves	Short waves	Medium waves	Long waves	Medium/long waves
Radiant efficiency	92%	60%	40%	50%
Switch on/off time	< 1 sec	30 sec	5 min	20 sec
Heating principle	Radiation	Radiation & convection	Convection	Radiation & convection
Focusing with reflector	Good focusing	Possible	Hardly not relevant	Partially (combustion gases exhaust)
Polluent emission	None	None	None	Emission of CO ₂ & NO _x

DR. FISCHER infrared lamps use this radiation principle. They directly heat an object or person at which they are directed without warming the surrounding air. This is what makes them highly efficient heat sources.

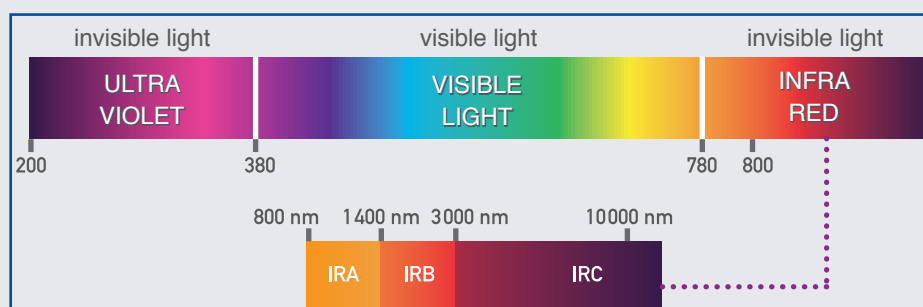

Infrared halogen lamps:

Infrared halogen lamps are used for a wide range of applications:

comfort heating, processing plastics (bottle blowing, thermoforming), semiconductor industry, infrared heating cabins, food catering, zone heating, vehicle painting etc.

In addition to standard products, we manufacture a large number of special lamps designed for our partners' specific applications. Every day, we work with our customers to find together the best solutions for their needs.

Benefits & Advantages of DR. FISCHER infrared halogen lamps:

Our infrared halogen lamps have a broad emission spectrum. Main part is the IR-A radiation. IR-A offers the highest energy density and best efficiencies for most applications.

Advantages:

- 90% of the heat is available within one second (no pre-heating),
- Can be directed using reflectors, meaning that even small partial areas can also be heated effectively,
- Intensity is continuously variable from 0 - 100%,
- More than 90% of the energy used is converted to IR heat,
- 5,000 hours lifetime independently of the cycles of operation for reduced maintenance cost,
- No emissions, no oxygen consumption and no pollution from air or dust movement, no odor,
- Our lamps' tubes are robust because the quartz we use is resistant to thermal shocks. Our special technology prevents the lamps from getting black on the inside. Therefore there is no reduction of infrared radiation over time,
- The most modern and sophisticated technology makes our infrared halogen lamps reliable, safe and perfect for energy savings.

Infrared within the electromagnetic spectrum:

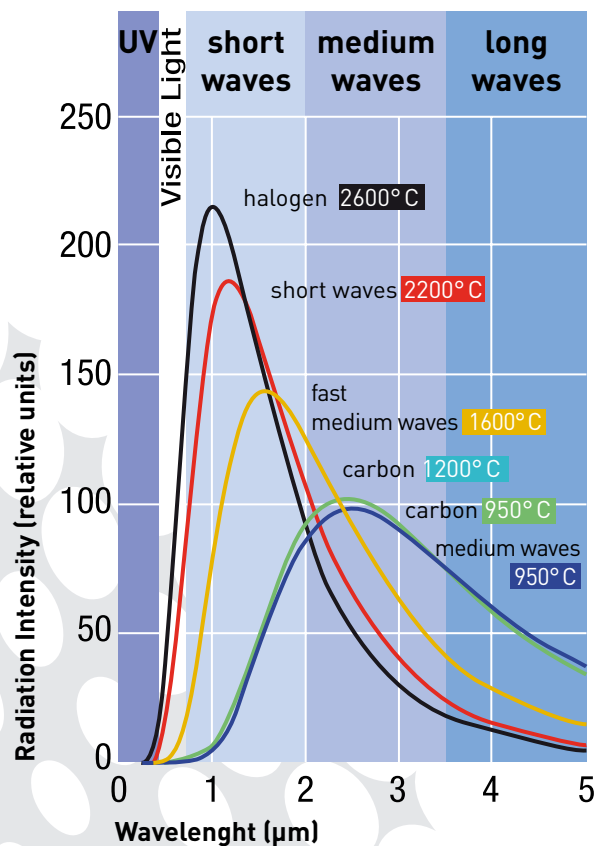

Spectral radiation distribution at the same electrical power ratings



Industrial solutions



DR. FISCHER infrared halogen lamps for Industrial applications

DR. FISCHER infrared halogen lamps are the ideal, high-power heat source for a wide range of industrial heating applications such as paper processing, printing, metalworking, the food industry, plastic production, car manufacturing, glass processing and machining, the textile industry, the manufacture of solar

installations, wood transforming and many other things.

The halogen lamps do not turn over time, there is therefore no reduction of infrared output. This guarantees process stability and reliability throughout the lamp life. Full power is reached within a few hundred milliseconds after switching on. The power







of the lamp is fully dimmable, with an instant adjustment of the required heat level between 0 and 100%. DR. FISCHER infrared halogen lamps are the most compact heat sources available.

Dedicated DR. FISCHER infrared lamps for Industrial applications







Support	Application		Color code
Plastics	<ul style="list-style-type: none"> • Bottle blowing • Thermoforming • Plastic forming 	<ul style="list-style-type: none"> • Welding • Serigraphy • Strapping 	
Paper	<ul style="list-style-type: none"> • Drying • Copying • Offset printing 	<ul style="list-style-type: none"> • Ink jet • Serigraphy 	
Food	<ul style="list-style-type: none"> • Food catering 	<ul style="list-style-type: none"> • Food processing 	
Wood & Composites	<ul style="list-style-type: none"> • Drying • Curing 	<ul style="list-style-type: none"> • Powder coating 	
Shoes & Fabrics	<ul style="list-style-type: none"> • Drying 	<ul style="list-style-type: none"> • Curing 	
Metal	<ul style="list-style-type: none"> • Strapping • Coil coating 	<ul style="list-style-type: none"> • Powder coating 	
Paint	<ul style="list-style-type: none"> • Automobile repair shops 	<ul style="list-style-type: none"> • Powder coating 	
Animal care	<ul style="list-style-type: none"> • Breeding and rearing of animals 	<ul style="list-style-type: none"> • Veterinary clinics, zoos, pet shops and beauty parlors 	



Overview of caps

Cap type	
SK11	
SK15 SK15 weatherproof	
R7s R7s + lead	
U-clip	
ClicFit	
X-clip X-bended	
Other caps	9 x 14 E26/E27 FA4 + lead J7s Ø 10 x 15.5 SK9 + lead

Overview of terminals

Cable with	
Splice	
Fork	
Faston	
Insulated tab	
Ring	
Special	

Clear lamps

They are tubular double-ended infrared halogen lamp used as a high-power and high-efficiency heat source for various industrial applications.

This large range of lamps matches all kinds of industrial patterns thanks to numerous available connections and lengths. They

are compact, clean and outstandingly energy-efficient.

Our clear DR. FISCHER infrared halogen lamps are the technology of choice for a wide range of applications like heating, drying, curing, cooking and many more.

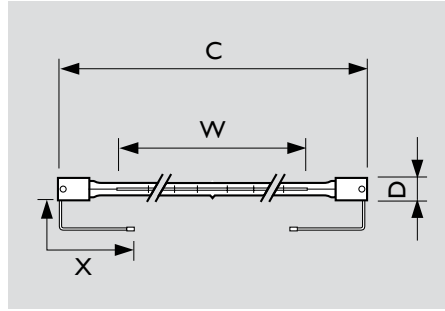

DR. FISCHER Clear lamps
short waves

Type #	Watt	Volt	Total length mm (C)	Heating length mm (W)	Base	Bulb diameter mm (D)	Co-our temp. K	Burning position	Average life (hrs)	Cable (X)	Terminal	Qty box (pc)	Order #	Ap-plica-tions
13912R	200	230	189.1	120.0	R7s	11.0	2,300	Horiz.	5,000	NA	NA	10	924530344216	All
13908R	300	230	117.5	64.0	R7s	11.0	2,500	Horiz.	1,000	NA	NA	10	923850343301	
13908Z	300	230	122.0	60.0	SK15	11.0	2,500	Horiz.	1,000	140/140	splice	10	924527144216	
13908R	300	230	117.5	64.0	R7s	11.0	2,500	Any	5,000	NA	NA	10	924591444201	
13908Z	300	230	122.0	64.0	SK15	11.0	2,400	Any	5,000	140/140	splice	10	924592244216	All
13908X	300	230	134.0	61.0	X-CLIP	NA	2,500	Horiz.	1,000	NA	NA	10	924593344216	All
13939F-V	400	110	148.0	NA	SK11	11.0	2,150	Horiz.	5,000	105/105	faston	25	924513731926	
13939F-V	400	230	148.0	NA	SK11	10.0	2,250	Horiz.	5,000	105/105	faston	25	924513744226	
13169X	500	120	242.0	142.0	X-CLIP	11.0	2,450	Horiz.	5,000	NA	NA	10	923850032316	All
13169R	500	235	220.6	165.0	R7s	11.0	2,450	Horiz.	5,000	NA	NA	10	923946844516	All
13169R	500	235	220.6	165.0	R7s	NA	2,400	Horiz.	5,000	NA	NA	6	923946844524	All
14120R	500	480	726.0	638.0	R7s	11.0	2,550	Horiz.	5,000	NA	NA	10	924543851716	All
13169CF/850	500	235	230.5	160.0	ClicFit	19.0	2,400	Horiz.	5,000	NA	NA	10	924565044944	
13790R	650	220	550.4	495.0	R7s	11.0	2,200	Horiz.	5,000	NA	NA	10	923947342916	
14174R	650	220	189.1	124.0	R7s	11.0	2,900	Any	500	NA	NA	10	924573344110	All
13842Z	700	240	216.0	150.0	SK15	11.0	2,600	Horiz.	5,000	140/140 insulated	splice	10	924527045516	
13195X	1,000	235	370.0	272.0	X-CLIP	11.0	2,500	Horiz.	5,000	NA	NA	10	923851043916	All
13713X	1,000	235	370.0	272.0	X-CLIP	11.0	2,450	Any	5,000	NA	NA	10	923851543916	All
1000T3/CL	1,000	240	306.0	254.0	U-CLIP	11.0	2,500	Horiz.	5,000	146/146	splice	10	924517945516	All
13402Z	1,000	235	355.0	272.0	SK15	11.0	2,500	Any	5,000	200/200 insulated	fork	10	924533544916	
13195U	1,000	235	346.0	270.0	U-CLIP	11.0	2,500	Horiz.	5,000	202/202	splice	10	924585843916	All
14209X	1,000	120	363.0	280.0	X-CLIP	11.0	2,500	Any	5,000	NA	NA	10	924588936316	All
13941Z	1,500	235	352.0	273.0	SK15	11.0	2,950	Horiz.	1,000	1200/1200	splice	10	924526844916	All

Type #	Watt	Volt	Total length mm (C)	Heating length mm (W)	Base	Bulb diameter mm (D)	Co-lour temp. K	Burning position	Average life (hrs)	Cable (X)	Terminal	Qty box (pc)	Order #	Ap-plications
13123Z	1,500	235	355.0	280.0	SK15	11.0	2,300	Horiz.	5,000	300/300 double insulated	fork	10	924591344916	All
13992Z	1,500	235	355.0	280.0	SK15	11.0	2,300	Horiz.	5,000	600/600	splice	10	924597444916	All
13994Z	1,500	235	355.0	280.0	SK15	11.0	2,300	Horiz.	5,000	600/600	splice	10	924598444916	All
1600T3/CL	1,600	240	503.0	406.0	U-CLIP	11.0	2,500	Horiz.	5,000	146/146	splice	10	924518143816	
13252/99	1,600	600	731.5	418.0	R7s+ lead	11.0	2,700	Horiz.	5,000	190/190 insulated	splice	10	924533951216	
13568U	1,600	144	222.5	155.0	U-CLIP	11.0	2,500	Horiz.	5,000	150/150	fork	10	924586057706	All
13168V	2,000	235	350.0	280.0	NA	NA	2,450	Any	5,000	138/138 insulated	ring	10	923850444516	All
13168X	2,000	235	370.0	280.0	X-CLIP	11.0	2,500	Any	5,000	NA	NA	10	923852543916	All
13245X	2,000	400	512.0	416.0	X-CLIP	11.0	2,450	Horiz.	5,000	NA	NA	10	923853057916	All
13765X	2,000	400	512.0	410.0	X-CLIP	11.0	2,450	Any	5,000	NA	NA	10	923853157916	All
2MT3/1CL/HT/UB0	2,000	240	305.0	254.0	U-CLIP	11.0	2,500	Any	5,000	146/146	splice	10	924518545516	All
14141X	2,000	400	370.0	282.0	X-CLIP	11.0	2,700	Any	5,000	NA	NA	10	924555249116	All
13168Z	2,000	235	355.0	280.0	SK15	11.0	2,500	Any	5,000	200/200 insulated	fork	10	924571744916	All
13168VL	2,000	230	350.0	280.0	R7s+ lead	11.0	2,450	Any	5,000	146/146 insulated	splice	10	924590644916	All
14193Z	2,000	235	360.0	278.0	SK15	11.0	2,500	Horiz.	5,000	160/160	ring	10	924592944916	All
13991V	2,000	235	350.0	280.0	NA	NA	2,450	Any	5,000	148/148	splice	10	924597344916	All
13997Z	2,000	235	355.0	280.0	SK15	11.0	2,500	Horiz.	5,000	600/600	splice	10	924598944916	All
2500T3/CL	2,500	480	731.0	638.0	U-CLIP	11.0	2,550	Horiz.	5,000	146/146	splice	10	924526451616	All
13848/99	2,500	600	1,059.0	636.0	R7s	NA	2,500	Horiz.	5,000	146/146	splice	6	924529151216	All
14182V	2,500	235	350.0	284.0	NA	11.0	2,450	Any	5,000	138/138 insulated	splice	10	924534844916	All
14168C	2,500	575	730.0	636.0	R7s	NA	2,500	Horiz.	5,000	146/146	splice	6	924570551516	All
14190V	2,500	235	350.0	284.0	NA	NA	2,450	Any	5,000	85/85	splice	10	924580044916	All
14140C	2,500	400	600.0	504.0	R7s	11.0	2,650	Horiz.	5,000	303/303	splice	10	924595349116	All
13230X	3,000	400	802.0	700.0	X-CLIP	11.0	2,450	Any	5,000	NA	NA	10	923854057916	All
13215X	3,000	400	802.0	700.0	X-CLIP	11.0	2,450	Horiz.	5,000	NA	NA	10	923854257916	All
13565X	3,000	235	370.0	277.0	X-CLIP	13.0	2,500	Any	5,000	NA	NA	10	923945644506	All
14185X	3,000	235	348.0	275.0	X-CLIP	13.5	2,450	Any	5,000	NA	NA	10	924510143916	All
13565V	3,000	235	350.0	277.0	NA	13.5	2,500	Any	5,000	138/138 insulated	ring	10	924514344506	All
14217X	3,000	230	795.0	700.0	X-CLIP	11.0	2,400	Any	5,000	NA	NA	10	924590844216	All
14219X	3,000	400	483.0	280.0	X-CLIP	11.0	2,650	Any	5,000	NA	NA	10	924591749116	All
14194Z	3,000	235	360.0	285.0	SK15	11.0	2,650	Horiz.	5,000	160/160	ring	10	924592844916	All
14205C	3,650	480	1,061.0	962.0	R7s+ lead	11.0	2,500	Horiz.	5,000	146/146	splice	48	924516851716	All
3800T3/CL/UB	3,800	575	1,062.0	967.0	U-CLIP	11.0	2,500	Any	5,000	146/146	splice	6	924517351116	All
14206C	3,800	570	1,058.0	963.0	R7s+ lead	11.0	2,500	Any	5,000	146/146	splice	48	924520051016	All
14198X	4,000	235	350.0	277.0	X-bended	16.5	2,400	Any	5,000	NA	NA	10	924528744916	

- Plastics
- Paper
- Food
- Wood & Composites
- Shoes & Fabrics
- Metal
- Paint
- Animal care

For custom solutions (base, watt, volt, applications...), please contact us.

Translucent lamps

Our DR. FISCHER frosted lamps have a slightly textured translucent glass that has a whitish appearance, as if a layer of fog or frost lies over the bulb. This may be inherent in the glass or a coating added to the bulb.

- Plastics
- Paper
- Food
- Wood & Composites
- Shoes & Fabrics
- Metal
- Paint
- Animal care

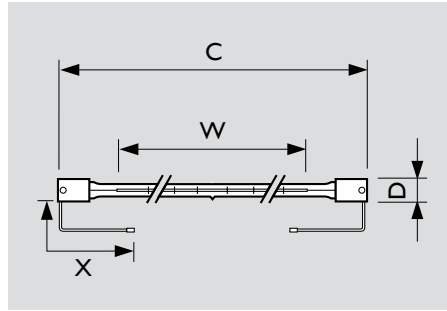
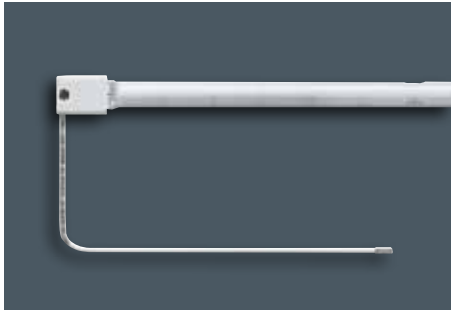

DR. FISCHER Translucent lamps short waves

Average lifetime	5,000 hours
Bulb diameter (D)	11 mm

Type #	Watt	Volt	Total length mm (C)	Heating length mm (W)	Base	Colour temp. K	Burning position	Cable (X)	Terminal	Qty box (pc)	Order #	Applications
500T3	500	120	224.0	127.0	U-CLIP	2,500	Horiz.	146/146	splice	10	924517636316	All
1000T3	1,000	240	351.0	254.0	U-CLIP	2,500	Horiz.	146/146	splice	10	924517843816	All
1600T3/7	1,600	240	498.5	406.0	R7s	2,550	Horiz.	NA	NA	10	924519043816	All
1600T3	1,600	277	503.0	404.0	U-CLIP	2,500	Horiz.	146/146	splice	10	924520746916	All
3800T3	3,800	575	1,062.0	965.0	U-CLIP	2,500	Horiz.	146/146	splice	6	924518451116	All

For custom solutions (base, watt, volt, applications...), please contact us.

Gold-coated lamps

Our revolutionary DR. FISCHER Gold-coated lamp is a unique heat lamp based on our world-leading technology and knowledge to meet our customers' needs for specific applications requiring a direct heat performance and reduced glare. Our

DR. FISCHER Gold-coated heat lamps are simple, effective and reliable heat sources which are both energy-efficient and comfortable.

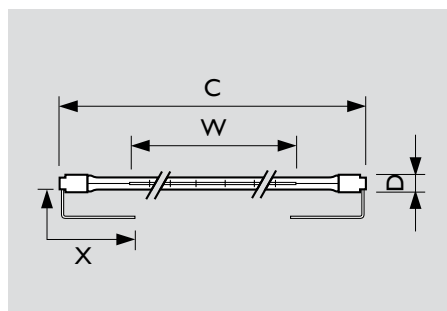

DR. FISCHER Gold-coated lamps short waves

Bulb diameter (D)	11 mm
-------------------	-------

Type #	Watt	Volt	Total length mm (C)	Heating length mm (W)	Base	Colour temp. K	Burning position	Average life (hrs)	Cable (X)	Terminal	Qty box (pc)	Order #	Applications
15106R	500	235	297.0	242.0	R7s	2,250	Horiz.	2,000	NA	NA	6	924592744950	
15008X	1,000	235	370.0	272.0	X-CLIP	NA	Any	5,000	NA	NA	10	924527344516	
15105R	1,000	235	297.0	242.0	R7s	2,600	Horiz.	2,000	NA	NA	6	924592544916	
15085R	1,300	240	254.1	185.0	R7s	NA	Horiz.	2,000	NA	NA	40	924585345502	All
15085R	1,300	240	254.1	185.0	R7s	NA	Horiz.	2,000	NA	NA	10	924585345516	All

For custom solutions (base, watt, volt, applications...), please contact us.

Double-sleeve lamps

DR. FISCHER Double-sleeve lamps feature a quartz double envelope for a total security and an easy handling in catering applications. Maintenance is simplified as the lamp is easily cleanable with a duster. Above all, thanks to the low internal tube

pressure, there is no risk of lamp explosion or quartz breakage. We know that safety is key in the food preparation market.

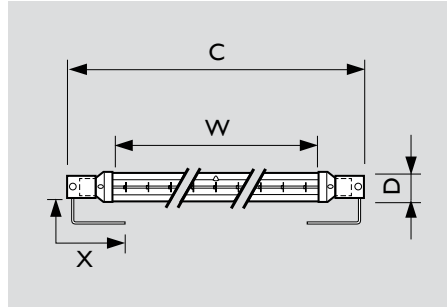

**DR. FISCHER
Double-sleeve lamps
short waves**

Average lifetime | 5,000 hours

Type #	Watt	Volt	Total length mm (C)	Heating length mm (W)	Base	Bulb diameter mm (D)	Colour temp. K	Burning position	Cable (X)	Terminal	Qty box (pc)	Order #	Applications
13908J	300	230	117.5	64.0	J7s	20.5	2,400	Horiz.	NA	NA	10	924592144224	
13169Z/850	500	235	225.0	160.0	SK15	19.0	2,400	Horiz.	230/230	splice	10	924552344924	

For custom solutions (base, watt, volt, applications...), please contact us.

PAR38 lamps

Our DR. FISCHER infrared halogen PAR38 lamps offer a direct heat, without air stream, for animals care and food catering applications. With its compact form, its reinforced construction and its universal base, our PAR38 is the safest and most ef-

ficient choice for working in hard and binding conditions like farms or professional kitchens.

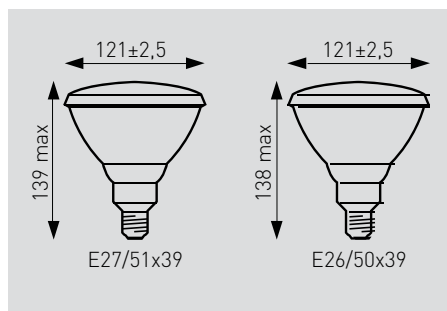

**DR. FISCHER PAR38 lamps
short waves**

Average lifetime | 5,000 hours

Bulb diameter (D) | 121 mm

Type #	Watt	Volt	Total length mm (C)	Heating length mm (W)	Base	Colour temp. K	Burning position	Cable (X)	Terminal	Qty box (pc)	Order #	Applications
PAR 38	75	230	139.0	NA	E27/51 x 39	2,650	Any	NA	NA	8	802207544208	
PAR 38	75	120	138.0	NA	E26/50 x 39	2,750	Any	NA	NA	8	802207536308	

For custom solutions (base, watt, volt, applications...), please contact us.

White Integrated Reflector lamps

The DR. FISCHER White Integrated Reflector range incorporates an embedded white reflector. It increases the infrared short waves intensity towards the exposure area without any large external reflector. It is the most simple way to save energy.

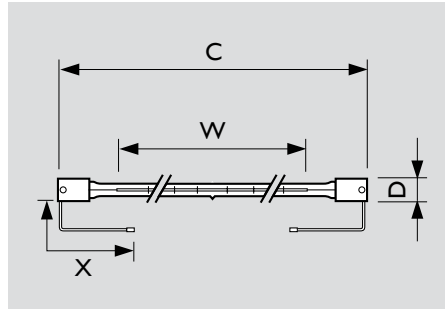
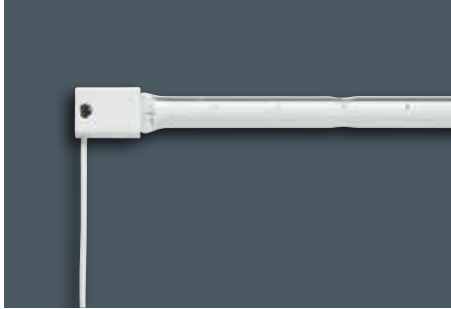

DR. FISCHER White Integrated Reflector lamps short waves

Average lifetime	5,000 hours
Bulb diameter (D)	11 mm

Type #	Watt	Volt	Total length mm (C)	Heating length mm (W)	Base	Colour temp. K	Burning position	Cable (X)	Terminal	Qty box (pc)	Order #	Applications
13169X/98	500	120	242.0	142.0	X-CLIP	2,450	Horiz.	NA	NA	10	923850232316	All
13169Z/98	500	235	227.0	159.0	SK15	2,300	Horiz.	200/200	fork	10	923852744516	All
13169Z/98L	500	235	277.0	159.0	SK15	2,400	Horiz.	300/300 insulated	fork	10	924588244916	All
13169X/98	500	235	236.0	142.0	X-CLIP	2,300	Horiz.	NA	NA	10	924588644916	All
13169/998	500	235	254.0	165.0	9x14	2,300	Horiz.	NA	NA	10	924591944916	All
14172Z/98	600	120	135.0	70.0	SK15	2,700	Horiz.	150/150	fork	10	924541536316	
13842Z/98	700	240	216.0	149.0	SK15	2,600	Horiz.	155/155 insulated	fork	10	924588844516	All
13195X/98	1,000	235	370.0	272.0	X-CLIP	2,500	Horiz.	NA	NA	10	923851443916	
13713Z/98	1,000	235	355.0	272.0	SK15	2,500	Any	200/200 insulated	fork	10	923853544516	All
13713Z/98	1,000	235	355.0	272.0	SK15	2,500	Any	200/200 insulated	fork	50	923853544550	All
13195Z/98	1,000	235	355.0	272.0	SK15	2,500	Horiz.	200/200 insulated	fork	10	923854344516	All
13713X/98	1,000	235	370.0	272.0	X-CLIP	2,450	Any	NA	NA	10	923896044516	All
13207/998	1,000	110	204.0	126.0	FA4+lead	2,400	Any	200/200	fork	10	923945231916	
13195X/98C	1,000	235	400.0	272.0	X-CLIP	2,400	Horiz.	NA	NA	10	924553144916	
13713Z/98L	1,000	235	355.0	272.0	SK15	2,500	Any	300/300 insulated	fork	10	924575744916	
14187Z/98	1,000	400	355.0	274.0	SK15s	2,550	Horiz.	200/200 insulated	fork	10	924579249116	
14134Z/98	1,200	235	224.0	155.0	SK15	2,600	Horiz.	150/150	fork	10	924537144916	
13561Z/98	1,200	144	228.0	150.0	SK15	2,500	Horiz.	150/150	fork	10	924548257716	
13561U/98	1,200	144	222.5	150.0	U-CLIP	2,400	Horiz.	150/150	fork	10	924586157706	All
14135Z/98	1,600	235	228.0	155.0	SK15	2,600	Horiz.	150/150	fork	10	924537244916	
13568Z/98	1,600	144	228.0	155.0	SK15	2,500	Horiz.	150/150	fork	100	924548357710	
13568Z/98	1,600	144	228.0	155.0	SK15	2,500	Horiz.	150/150	fork	10	924548357716	
13568U/98	1,600	144	222.5	155.0	U-CLIP	2,500	Horiz.	150/150	fork	10	924586257706	All

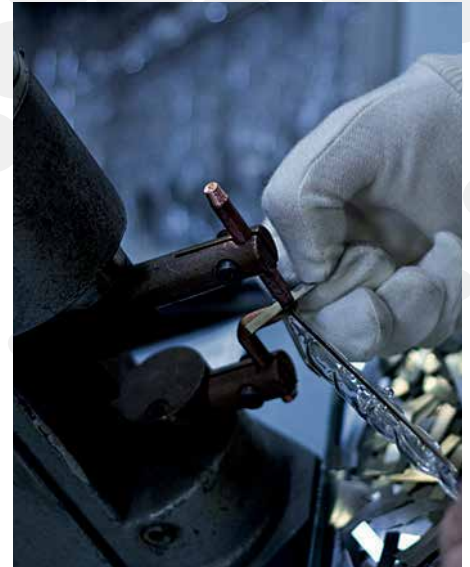

- Plastics
- Shoes & Fabrics
- Paper
- Metal
- Food
- Paint
- Wood & Composites
- Animal care

Type #	Watt	Volt	Total length mm (C)	Heating length mm (W)	Base	Colour temp. K	Burning position	Cable (X)	Terminal	Qty box (pc)	Order #	Ap-plica-tions
13245X/98	2,000	400	512.0	416.0	X-CLIP	2,450	Horiz.	NA	NA	10	923852957916	All
13168Z/98	2,000	235	355.0	280.0	SK15	2,500	Any	200/200 insulated	fork	10	923853644516	All
13168Z/98	2,000	235	355.0	280.0	SK15	2,500	Any	200/200 insulated	fork	50	923853644550	All
13213Z/98F	2,000	235	355.0	280.0	SK15s	2,500	Horiz.	200/200 insulated	fork	10	924500344516	
13765X/98	2,000	400	508.0	410.0	X-CLIP	2,450	Any	NA	NA	10	924505457916	
13214Z/98	2,000	230	656.0	500.0	SK15	2,400	Horiz.	500/500 insulated	splice	10	924532344216	
14103Z/98	2,000	235	355.0	280.0	SK15	2,500	Horiz.	230/230 insulated	splice	10	924534744916	
14136Z/98	2,000	235	355.0	280.0	SK15	2,700	Horiz.	200/200	fork	10	924547744916	All
14207X/98	2,000	400	370.0	274.0	X-CLIP	2,600	Any	NA	NA	10	924548049116	
14132Z/98	2,000	235	787.5	700.0	SK15	2,450	Horiz.	500/500	splice	10	924552644916	
13168X/98	2,000	235	370.0	280.0	X-CLIP	2,500	Any	NA	NA	10	924574244916	All
14188Z/98	2,000	400	355.0	274.0	SK15s	2,700	Horiz.	200/200 insulated	fork	10	924579349116	
14210Z/98	2,000	235	355.0	280.0	SK15	2,450	Any	300/300	splice	10	924589844916	All
13213Z/98F	2,000	235	355.0	280.0	SK15s	2,500	Horiz.	210/210	fork	50	924500344550	All
13995Z/98	2,000	200	355.0	280.0	SK15	2,550	Any	200/200	fork	10	924598639516	All
14137Z/98	2,500	235	355.0	280.0	SK15	2,700	Horiz.	200/200 insulated	fork	10	924547844916	
14140C/98	2,500	400	600.0	506.0	R7s+lead	2,550	Horiz.	300/300	splice	10	924554749116	
14143Z/98	2,500	400	355.0	280.0	SK15s	2,700	Horiz.	200/200 insulated	fork	10	924556149116	
14143Z/98	2,500	400	355.0	280.0	SK15s	2,700	Horiz.	200/200 insulated	fork	20	924556149150	
14211Z/98	2,500	235	355.0	280.0	SK15	2,500	Any	300/300 insulated	splice	10	924589944916	All
13230X/98	3,000	400	802.0	700.0	X-CLIP	2,450	Any	NA	NA	10	923854157916	All
14107Z/98	3,000	230	787.0	696.0	SK15	2,300	Horiz.	500/500 insulated	splice	10	924536344216	
14121Z/98	3,000	235	355.0	280.0	SK15	2,650	Horiz.	230/230	splice	10	924544944916	
14144Z/98	3,000	400	355.0	280.0	SK15s	2,650	Horiz.	200/200 insulated	fork	10	924556249116	
14177C/98	3,000	400	784.0	700.0	R7s+lead	2,450	Horiz.	300/300 insulated	splice	10	924574449116	All
14212Z/98	3,000	235	355.0	280.0	SK15	2,550	Horiz.	300/300 insulated	splice	10	924590044916	All

For custom solutions (base, watt, volt, applications...), please contact us.

New White Integrated Reflector lamps - LRI

Our New White Integrated Reflector (LRI) is focusing 75% of the infrared short waves towards the material to be heated. As such, the electricity consumption is reduced by at least 10% compared to the traditional infrared emitters.

- Plastics
- Paper
- Food
- Wood & Composites
- Shoes & Fabrics
- Metal
- Paint
- Animal care

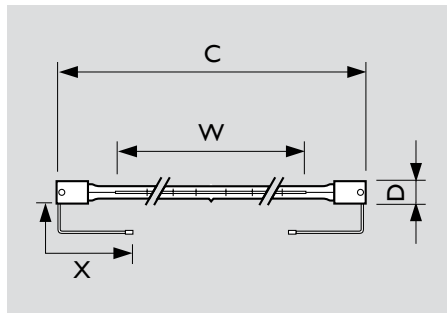
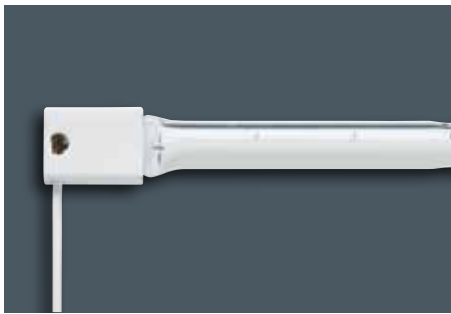

DR. FISCHER LRI lamps
short waves

Type #	Watt	Volt	Total length mm (C)	Heating length mm (W)	Base	Bulb diameter mm (D)	Colour temp. K	Burning position	Average life (hrs)	Cable (X)	Terminal	Qty box (pc)	Order #	Applications
13908R/83	300	230	117.5	64.0	R7s	NA	2,400	Any	5,000	NA	NA	100	924591544201	All
13908J/83	300	230	117.5	64.0	J7s	20.5	2,400	Horiz.	5,000	NA	NA	10	924597244224	
14242R/83	500	230	117.5	69.0	R7s	12.0	2,900	Any	2,000	NA	NA	10	924598144201	All
13993Z/83	1,500	235	355.0	280.0	SK15	11.0	2,300	Horiz.	5,000	2010/2010	splice	10	924597844916	All
14213Z/83	1,600	235	228.0	155.0	SK15	11.0	2,600	Horiz.	5,000	150/150	fork	10	924590144916	
13996Z/83	1,600	235	222.0	153.0	SK15	11.0	2,700	Any	5,000	200/200	fork	10	924598744916	All
14200Z/83	2,000	235	355.0	280.0	SK15s	11.0	2,500	Horiz.	5,000	230/230 insulated yellow	splice	10	924587944916	All
14216Z/83	2,000	235	355.0	280.0	SK15	11.0	2,700	Horiz.	5,000	200/200 insulated	fork	10	924590744916	All
13168V/83	2,000	235	350.0	275.0	NA	11.0	2,500	Any	5,000	138/138 insulated	ring	10	924592044916	All
14229Z/83	2,000	400	355.0	284.0	SK15s	11.0	2,700	Horiz.	5,000	300/300	fork	10	924595049116	
14196Z/83	2,500	400	382.0	311.0	SK15s	11.0	2,700	Horiz.	5,000	230/230 insulated	splice	10	924587649116	All
14230Z/83	2,500	400	355.0	287.0	SK15	11.0	2,700	Horiz.	5,000	300/300	fork	10	924595149116	
14140C/83	2,500	400	603.0	504.0	R7s +lead	11.0	2,650	Horiz.	5,000	303/303	splice	10	924599049116	All
14197Z/83	3,000	400	382.0	313.0	SK15s	11.0	2,700	Horiz.	5,000	230/230 insulated yellow	splice	10	924587749116	All
14144Z/83	3,000	400	355.0	280.0	SK15s	11.0	2,550	Horiz.	5,000	200/200 insulated	fork	10	924591849116	

For custom solutions (base, watt, volt, applications...), please contact us.

Proximity Reflector Lamps - LRP™

Our DR. FISCHER Proximity Reflector Lamp (LRP™) is the optimum infrared halogen technology for your industrial applications. This proximity reflector uses and precisely focuses 100% of the radiation of the lamp on specific areas. The electricity consumption is reduced up to 40% compared to traditional infrared halogen emit-

ters. Our DR. FISCHER Proximity Reflector Lamp (LRP™) is easy to install with its Plug&Play mechanism, and gives the best zoning accuracy currently available on the market.

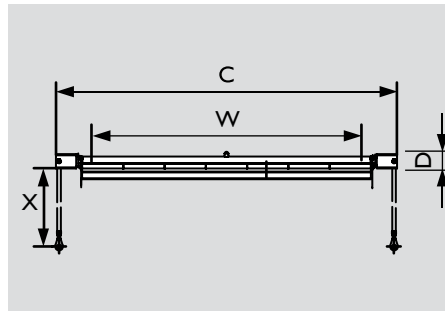

**DR. FISCHER LRP™ lamps
short waves**

Average lifetime | 5,000 hours

Type #	Watt	Volt	Comments	Total length mm (C)	Heating length mm (W)	Base	Bulb diameter mm (D)	Colour temp. K	Burning position	Cable (X)	Terminal	Qty box (pc)	Order #	Applications
14231 /LRP-SW	1,000	235	LRP V119	355.0	280.0	SK15s-21	9.9	2,500	Horiz.	310/310 insulated white	splice	10	9245 957 44916	All
14232 /LRP-SW	1,500	235	LRP V119	355.0	280.0	SK15s-21	9.9	2,350	Horiz.	310/310 insulated white	splice	10	9245 958 44916	All
14192 /LRP	1,700	235	LRP V119	355.0	280.0	SK15s-21	9.9	2,700	Horiz.	230/230 insulated white	splice	10	9245 833 44916	
14222 /LRP	1,700	235	LRP V114	355.0	280.0	SK15s-21	9.9	2,700	Horiz.	230/230 insulated white	splice	10	9245 930 44916	
14233 /LRP-SW	1,700	235	LRP V119	355.0	280.0	SK15s-21	9.9	2,700	Horiz.	310/310 insulated white	splice	10	9245 959 44916	All
14214 /LRP	2,000	400	LRP V219	382.0	306.0	SK15s-21	9.9	2,600	Horiz.	230/230 insulated white	splice	10	9245 903 49116	
14215 /LRP	2,000	400	LRP V214	382.0	306.0	SK15s-21	9.9	2,600	Horiz.	230/230 insulated white	splice	10	9245 904 49116	
14224 /LRP	2,000	235	LRP V114	355.0	280.0	SK15-21	9.9	2,500	Horiz.	160/160 double insulated	ring	10	9245 943 44916	
14225 /LRP	2,000	235	LRP V119	355.0	280.0	SK15-21	9.9	2,500	Horiz.	160/160 double insulated	ring	10	9245 944 44916	
14234 /LRP-SW	2,000	235	LRP V119	355.0	280.0	SK15s-21	9.9	2,500	Horiz.	310/310 insulated white	splice	10	9245 960 44916	All
14236 /LRP-SW	2,000	400	LRP V119	355.0	284.0	SK15s-21	9.9	2,700	Horiz.	300/300 insulated white	splice	10	9245 962 49116	All
14237 /LRP-SW	2,500	400	LRP V119	355.0	287.0	SK15s-21	9.9	2,700	Horiz.	300/300 insulated white	splice	10	9245 963 49116	All
14226 /LRP	3,000	235	LRP V114	355.0	278.0	SK15-21	9.9	2,650	Horiz.	160/160 double insulated	ring	10	9245 945 44916	
14227 /LRP	3,000	235	LRP V119	355.0	278.0	SK15-21	9.9	2,650	Horiz.	160/160 double insulated	ring	10	9245 946 44916	
14235 /LRP-SW	3,000	235	LRP V119	355.0	278.0	SK15s-21	9.9	2,650	Horiz.	310/310 insulated white	splice	10	9245 961 44916	
14238 /LRP-SW	3,000	400	LRP V119	355.0	280.0	SK15s-21	9.9	2,650	Horiz.	300/300 insulated white	splice	10	9245 964 49116	All

For custom solutions (base, watt, volt, applications...), please contact us.

Fast medium waves

The range of wavelengths of optical radiation lies between 100 nm (in the UV) and 10 μm (in the IR). Medium waves or IR-B go from 1.4 to 3 μm . The specific requirements of our demanding customers will define the appropriate wavelength of our infrared lamps. Short waves emitters will be picked for their deep penetration while fast medium waves emitters will be chosen for fast surface heating.

Emission Spectrum

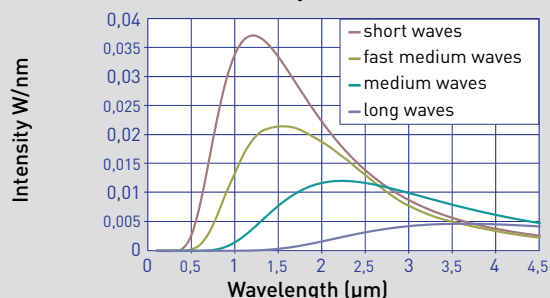

Clear lamps

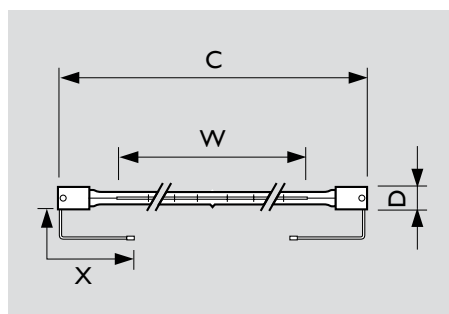
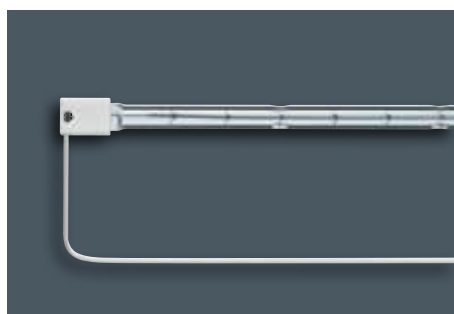

DR. FISCHER Clear lamps fast medium waves

Type #	Watt	Volt	Total length mm (C)	Heating length mm (W)	Base	Bulb diameter mm (D)	Colour temp. K	Burning position	Average life (hrs)	Cable (X)	Terminal	Qty box (pc)	Order #	Applications
13296C2	400	110	495.4	443.0	SK11	11.0	1,800	Horiz.	5,000	120/500	special	10	924554831916	
17018Z	650	235	236.0	164.0	SK15	11.5	1,700	Horiz.	5,000	140/140	splice	10	924569844916	
17018CF	650	235	239.0	170.0	CLICFIT	11.0	1,700	Horiz.	5,000	NA	NA	10	924586344916	All
17021Z	650	235	236.0	164.0	SK15	11.5	1,700	Horiz.	5,000	140/140	splice	10	924590244916	All
17018ZL	650	235	236.0	164.0	SK15	11.0	1,700	Horiz.	5,000	400/400 insulated	ring	10	924592444916	
17017Z	800	240	216.0	150.0	SK15	10.5	1,900	Horiz.	5,000	230/230 insulated	splice	10	924568745516	
17017CF	800	240	219.5	150.0	CLICFIT	10.5	1,900	Horiz.	5,000	NA	NA	10	924577845516	All
17011/99	1,000	120	294.0	225.0	$\varnothing 10 \times 15.5$	10.0	1,950	Horiz.	4,800	NA	NA	50	924557636316	All

For custom solutions (base, watt, volt, applications...), please contact us.

Translucent lamps

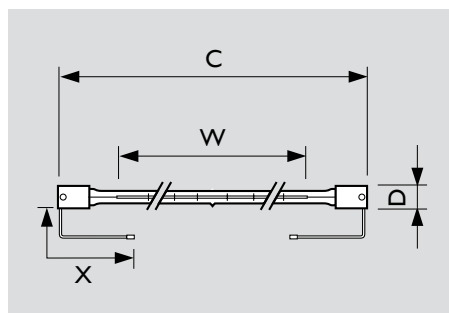
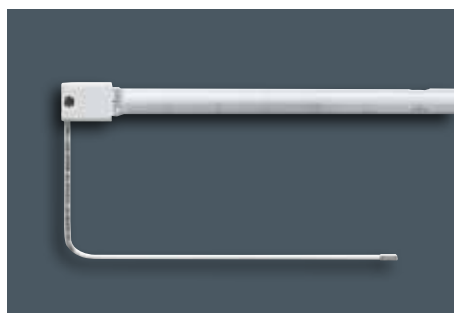

DR. FISCHER Translucent lamps fast medium waves

Type #	Watt	Volt	Total length mm (C)	Heating length mm (W)	Base	Bulb diameter mm (D)	Colour temp. K	Burning position	Average life (hrs)	Cable (X)	Terminal	Qty box (pc)	Order #	Applications
17007/99	600	230	425.0	345.0	SK9+Lead	10.5	1,800	Horiz.	5,000	350/350	splice	50	924547644216	All

For custom solutions (base, watt, volt, applications...), please contact us.

- Plastics
- Paper
- Food
- Wood & Composites
- Shoes & Fabrics
- Metal
- Paint
- Animal care

White Integrated Reflector lamps

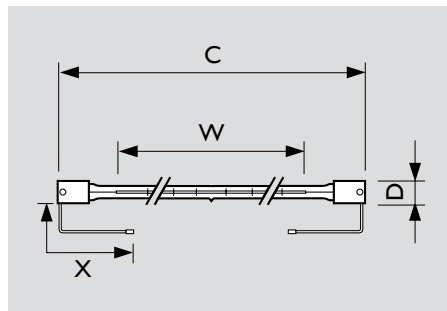
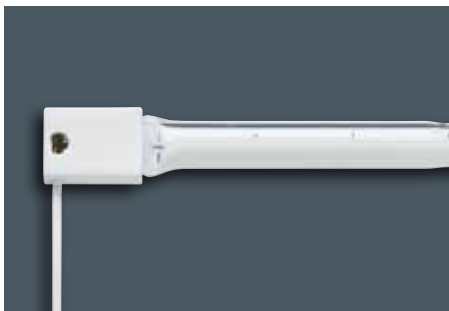

DR. FISCHER White Integrated Reflector lamps
fast medium waves
 Average lifetime | 5,000 hours

Type #	Watt	Volt	Total length mm (C)	Heating length mm (W)	Base	Bulb diameter mm (D)	Colour temp. K	Burning position	Cable (X)	Terminal	Qty box (pc)	Order #	Applications
17013Z/98	200	60	97.0	40.0	SK15	10.5	1,800	Horiz.	250/250	splice	20	924562526416	
17022Z/98	1,500	200	487.0	415.0	SK15	11.0	1,750	Horiz.	230/230	splice	10	924595239516	

For custom solutions (base, watt, volt, applications...), please contact us.

LRP™ lamps

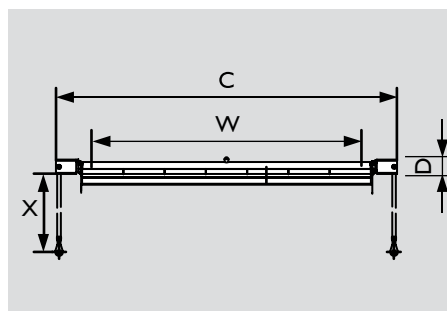

DR. FISCHER LRP™ lamps
fast medium waves

Type #	Watt	Volt	Total length mm (C)	Heating length mm (W)	LRP type	Base	Bulb diameter mm (D)	Colour temp. K	Burning position	Average life (hrs)	Cable (X)	Terminal	Qty box (pc)	Order #	Applications
14239 /LRP	750	235	355.0	280.0	V119	SK15s	9.9	1,700	Horiz.	5,000	300/300 insulated	splice	10	924596544916	All
14240 /LRP	1,000	235	355.0	280.0	V119	SK15s	9.9	1,700	Horiz.	5,000	300/300 insulated	splice	10	924596644916	All
14241 /LRP	1,500	235	355.0	280.0	V119	SK15s	9.9	1,700	Horiz.	5,000	300/300 insulated	splice	10	924596744916	All

For custom solutions (base, watt, volt, applications...), please contact us.



Comfort Heating solutions



DR. FISCHER infrared halogen lamps for Comfort Heating

DR. FISCHER IR lamps are the no. 1 choice for all comfort heating applications. DR. FISCHER coated infrared halogen emitters are the most efficient heating solution to increase well-being. Our range contains special products for both indoor and outdoor use.

DR. FISCHER Infrared short waves emitters guarantee comfortable warmth as

soon as the lamps are switched on. Thanks to the DR. FISCHER infrared halogen technology, it is not the air that is heated, but the specific areas where the warmth is required. Infrared halogen solutions are more energy saving, effective and precise than any other heating technology. Our DR. FISCHER Comfort Heating range can be used in yards, large areas such as café

and restaurant terraces, churches, halls, warehouses or even windy open places such as sports facilities for instance.

Areas of use

Support	Residential, domestic private user	Hospitality, commercial customer	
Outdoor & Open Space	<ul style="list-style-type: none"> • terrace • balcony • garden • swimming pool 	<ul style="list-style-type: none"> • bar/restaurant terrace • commercial front entrance • stadium VIP stand • gas station pump-in • golf practice • transportation waiting booth 	<ul style="list-style-type: none"> • transportation waiting deck • queuing area (nightclub, ...) • car washing station • camping • market place
Indoor & Enclosed Space	<ul style="list-style-type: none"> • bathroom • living room • veranda/greenhouse • secondary room: DIY... 	<ul style="list-style-type: none"> • hotel bathroom • place of worship • sport areas • bar/restaurant veranda • queuing area (cashier area, ...) 	<ul style="list-style-type: none"> • swimming pool • camping • market place • maternity (new-born warming)

Overview of caps

Cap type	
AK15 AK15/31	
R7s R7s + lead	
U-clip	
ClicFit	
SK15 SK15 weatherproof	

Overview of terminals

Cable with	
Splice	
Fork	
Faston	
Insulated tab	
Other terminals	Semi-strip

GARNETA™ lamps

The new DR. FISCHER Garneta™ lamps are the best heating solution for outdoor applications. They are robust short waves infrared halogen emitters that generate heat without bright light. All our Garneta™ lamps are weatherproof to easily allow the design of IP65 certified heaters. Their top of the range coating offers an exceptional heating performance and a glare

reduction of 99%. This creates a relaxing candlelight atmosphere. DR. FISCHER Garneta™ lamps can be used at any burning position. Their specific design makes them elegant because when lighted, in-dents are not seeable at all. It's the unrivaled aesthetic aspect, that makes our Garneta™ lamps suit extremely well to all kind of Comfort Heating applications.

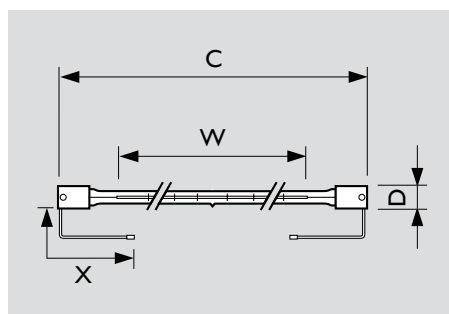

DR. FISCHER Garneta™ lamps short waves

Average lifetime	5,000 hours
Bulb diameter (D)	11 mm

Type #	Watt	Volt	Total length mm (C)	Heating length mm (W)	Base	Colour temp. K	Burning position	Cable (X)	Terminal	Qty box (pc)	Order #
26001Z	1,000	235	355.0	272.0	SK15	2,500	Any	600/600	splice	10	924593644916
26008Z	1,000	235	355.0	272.0	SK15	2,500	Any	500/500	splice	10	924597644916
26010Z	1,000	235	355.0	272.0	SK15	2,500	Any	213/213	splice	10	924597944916
26003Z	1,500	120	355.0	280.0	SK15	2,500	Any	600/600	splice	10	924594836316
26004A	1,500	235	366.0	280.0	AK15	2,300	Any	590/220 VDE black	splice	10	924595544916
26007Z	1,500	235	355.0	280.0	SK15	2,300	Any	500/500	splice	10	924597544916
26011Z	1,500	235	355.0	280.0	SK15	2,500	Any	213/213	splice	10	924598044916
26013A	1,500	235	366.0	280.0	AK15	2,300	Any	160/510	splice	10	924599144916
26002Z	1,500	240	355.0	280.0	SK15	2,500	Any	600/600	splice	10	924593745516
26005AK	2,000	235	375.0	280.0	AK15/31	2,500	Any	150/500	splice	10	924595644916
26006Z	2,000	235	355.0	273.0	SK15	2,500	Any	600/600	splice	10	924596844916
26009A	2,000	235	366.0	273.0	AK15	2,500	Horiz.	590/220 VDE black	splice	10	924597744916
26014A	2,000	235	366.0	273.0	AK15	2,500	Horiz.	160/510	splice	10	924599244916

HeLeN™ lamps

DR. FISCHER short waves infrared halogen lamps, based on the world-leading "HeLeN™"-technology developed and manufactured in our French factory for intense professional utilization. The high quality HeLeN™ lamps are designed to meet the requirements of the most demanding customers of the world. All our HeLeN™ lamps are low glare emitters and can be customizable for your application. Our HeLeN™ range is recognized as a French

top quality solution.

They are:

- simple
- dimmable
- efficient
- reliable
- comfortable
- economical

This makes the difference in the changing world of Comfort Heating.

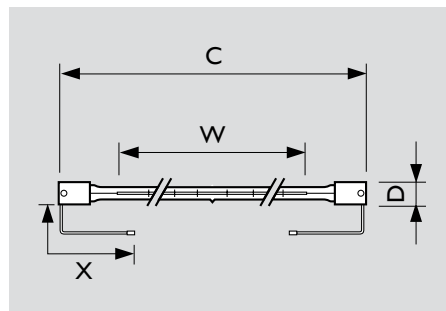
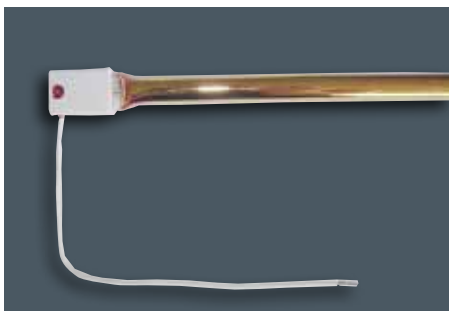

DR. FISCHER HeLeN™ lamps
short waves

Bulb diameter (D) | 11 mm

standard lamps

Type #	Watt	Volt	Total length mm (C)	Heating length mm (W)	Base	Co-lour temp. K	Burning position	Average life (hrs)	Cable (X)	Terminal	Qty box (pc)	Order #
15011Z	500	235	227.5	162.0	SK15	NA	Horiz.	5,000	300/300 insulated	fork	10	924529943216
15117Z	500	235	227.5	162.0	SK15	2,450	Horiz.	5,000	900/900	NA	10	924597144916
15101Z	850	240	198.0	125.0	SK15	NA	Horiz.	5,000	85/85 double insulated	insulated tab	10	924590545516
15007Z	1,000	235	355.0	272.0	SK15	NA	Horiz.	5,000	300/300 double insulated	faston	10	924524245516
15009Z	1,000	235	355.0	272.0	SK15	NA	Any	5,000	900/900 insulated	faston	10	924527444916
15049Z	1,000	120	355.0	280.0	SK15	NA	Any	5,000	300/300 double insulated	faston	10	924575136316
15066Z	1,000	235	355.0	272.0	SK15	NA	Horiz.	5,000	230/600 double insulated	splice	10	924579444916
15074C	1,000	235	380.0	280.0	R7s+lead	NA	Horiz.	5,000	300/915 insulated	splice	10	924580944916
15098Z	1,000	235	355.0	280.0	SK15	NA	Horiz.	5,000	300/300 double insulated	splice	20	924589244916
15007R	1,000	235	355.0	272.0	R7s	NA	Horiz.	5,000	NA	NA	10	924591244916
15026Z	1,100	230	532.0	446.0	SK15	NA	Any	5,000	85/85 insulated	insulated tab	10	924546744216
15040R	1,100	230	254.1	185.0	R7s	NA	Horiz.	2,000	NA	NA	40	924568844217
15040R	1,100	230	254.1	185.0	R7s	NA	Horiz.	2,000	NA	NA	10	924568844225
15025R	1,200	120	254.1	185.0	R7s	NA	Horiz.	2,000	NA	NA	40	924546036302
15025R	1,200	120	254.1	185.0	R7s	NA	Horiz.	2,000	NA	NA	10	924546036316
15028R	1,300	240	254.1	185.0	R7s	NA	Horiz.	2,000	NA	NA	40	924546045502
15028R	1,300	240	254.1	185.0	R7s	NA	Horiz.	2,000	NA	NA	10	924546045516
15004Z	1,500	235	355.0	280.0	SK15	NA	Horiz.	5,000	300/300 double insulated	faston	10	924523145516
15010Z	1,500	240	355.0	280.0	SK15	NA	Horiz.	5,000	300/300 double insulated	fork	10	924529745516
15015Z	1,500	120	355.0	280.0	SK15	NA	Horiz.	5,000	300/300 insulated	fork	10	924533831916
15030R	1,500	240	351.1	280.0	R7s	NA	Horiz.	5,000	NA	NA	10	924549845525
15034Z	1,500	235	355.0	280.0	SK15	NA	Any	5,000	300/300 double insulated	faston	10	924556744916
15004CF	1,500	235	359.0	280.0	ClicFit	NA	Horiz.	5,000	NA	NA	10	924565544944
15053C	1,500	235	352.0	280.0	R7s+lead	NA	Horiz.	5,000	15/15 insulated	NA	10	924576944916

Type #	Watt	Volt	Total length mm (C)	Heating length mm (W)	Base	Co-our temp. K	Burning position	Average life (hrs)	Cable (X)	Terminal	Qty box (pc)	Order #
15067Z	1,500	235	355.0	280.0	SK15	NA	Horiz.	5,000	230/600 double insulated	splice	10	924579544916
15075C	1,500	120	529.0	280.0	R7s+lead	NA	Any	5,000	300/915 insulated	splice	10	924582236316
15076C	1,500	235	352.0	280.0	R7s+lead	2,300	Any	5,000	162/512 insulated	semi-strip	10	924583844916
15096Z	1,500	235	355.0	280.0	SK15	NA	Any	5,000	300/300 double insulated	splice	20	924589044916
15099Z	1,500	235	355.0	280.0	SK15	NA	Horiz.	5,000	300/300 double insulated	splice	20	924589344916
15102Z	1,500	235	355.0	280.0	SK15	NA	Horiz.	5,000	140/500 insulated	splice	10	924591044916
15107Z	1,500	235	355.0	280.0	SK15	2,300	Horiz.	5,000	300/600	splice	10	924593144916
15113Z	1,500	235	355.0	280.0	SK15	2,300	Horiz.	5,000	140/140	splice	10	924594244916
15115Z	1,500	235	355.0	280.0	SK15	2,300	Horiz.	5,000	900/900	NA	10	924596944916
15071C	1,500	235	336.0	280.0	R7s+lead	NA	Horiz.	5,000	155/155 double insulated	splice	10	924580544916
15048C	1,650	240	529.0	382.0	R7s+lead	NA	Horiz.	5,000	915/300 insulated	splice	10	924575045516
15005Z	2,000	235	355.0	280.0	SK15	NA	Horiz.	5,000	300/300 double insulated	faston	10	924524445516
15005Z	2,000	235	355.0	280.0	SK15	NA	Horiz.	5,000	300/300 double insulated	faston	20	924524445550
15021Z	2,000	235	355.0	280.0	SK15	NA	Any	5,000	300/300 double insulated	faston	20	924544344916
15045Z	2,000	235	532.0	446.0	SK15	NA	Any	5,000	85/85 double insulated	insulated tab	10	924574644916
15052C	2,000	235	529.0	280.0	R7s+lead	NA	Any	5,000	915/300 insulated	splice	10	924576044916
15060Z	2,000	235	355.0	280.0	SK15	NA	Horiz.	5,000	140/140 double insulated	splice	10	924578144916
15068Z	2,000	235	355.0	280.0	SK15	NA	Horiz.	5,000	230/600 double insulated	splice	10	924579644916
15095Z	2,000	235	355.0	280.0	SK15	2,500	Any	5,000	300/900	faston	10	924588544916
15097Z	2,000	235	355.0	280.0	SK15	NA	Any	5,000	300/300 double insulated	splice	20	924589144916
15100Z	2,000	235	355.0	280.0	SK15	NA	Horiz.	5,000	300/300 double insulated	splice	20	924589444916
15103Z	2,000	235	355.0	280.0	SK15	2,500	Horiz.	5,000	140/500	splice	10	924591144916
15108Z	2,000	235	355.0	280.0	SK15	2,500	Horiz.	5,000	300/600	splice	10	924593244916
15116Z	2,000	235	355.0	280.0	SK15	2,500	Horiz.	5,000	900/900	NA	10	924597044916
15012U	3,000	235	503.0	423.0	U-Clip	2,300	Any	5,000	146/146	splice	10	924531045524
15012Z	3,000	235	512.0	415.0	SK15	2,300	Any	5,000	300/300 double insulated	faston	10	924590944916

weatherproof lamps

Type #	Watt	Volt	Total length mm (C)	Heating length mm (W)	Base	Co-our temp. K	Burning position	Average life (hrs)	Cable (X)	Terminal	Qty box (pc)	Order #
15084Z	500	235	226.0	165.0	SK15	NA	Horiz.	5,000	150/500 insulated	splice	10	924584944916
15111A	500	235	238.0	162.0	AK15	2,450	Horiz.	5,000	160/390	splice	10	924594044916
15070Z	1,000	235	355.0	272.0	SK15	NA	Horiz.	5,000	150/500 insulated	splice	10	924580344916
15079Z	1,000	235	355.0	272.0	SK15	NA	Any	5,000	500/500 insulated	splice	10	924584044916
15081Z	1,000	235	355.0	272.0	SK15	NA	Horiz.	5,000	200/600 double insulated	faston	10	924584444917
15090Z	1,000	235	355.0	272.0	SK15	NA	Any	5,000	600/600 double insulated	splice	10	924586544916
15112A	1,000	235	364.0	272.0	AK15	2,500	Any	5,000	160/510	splice	10	924594144916
15094Z	1,300	235	355.0	280.0	SK15	NA	Any	5,000	600/600 double insulated	splice	10	924586944916
15059Z	1,500	235	355.0	280.0	SK15	NA	Any	5,000	400/400 double insulated	splice	10	924579844916
15042Z	1,500	235	355.0	280.0	SK15	NA	Horiz.	5,000	150/500 insulated	splice	10	924583444916
15050Z	1,500	235	355.0	280.0	SK15	NA	Any	5,000	150/500 insulated	splice	10	924583644916
15080Z	1,500	235	355.0	272.0	SK15	NA	Any	5,000	500/500 insulated	splice	10	924584144916
15082Z	1,500	235	355.0	280.0	SK15	NA	Horiz.	5,000	200/600 double insulated	faston	10	924584544917
15091Z	1,500	235	355.0	280.0	SK15	NA	Any	5,000	600/600 double insulated	splice	10	924586644916
15093Z	1,500	120	355.0	280.0	SK15	NA	Any	5,000	600/600 double insulated	splice	10	924586836316
11001Z	1,500	235	355.0	280.0	SK15	NA	Any	5,000	150/500 insulated	splice	10	924589644916

Type #	Watt	Volt	Total length mm (C)	Heating length mm (W)	Base	Co-our temp. K	Burning position	Average life (hrs)	Cable (X)	Terminal	Qty box (pc)	Order #
15109A	1,500	235	366.0	280.0	AK15	2,300	Horiz.	5,000	300/650	splice	10	924593844916
15110A	1,500	235	366.0	280.0	AK15	2,300	Any	5,000	160/510	splice	10	924593944916
15119AK	1,700	235	375.0	286.0	AK15/31	2,500	Any	5,000	160/715	splice	10	924598344916
15057Z	2,000	235	355.0	280.0	SK15	NA	Any	5,000	400/400 double insulated	splice	10	924580244916
15043Z	2,000	235	355.0	280.0	SK15	NA	Horiz.	5,000	150/500 insulated	splice	10	924583544916
15051Z	2,000	235	355.0	280.0	SK15	NA	Any	5,000	150/500 insulated	splice	10	924583744916
15083Z	2,000	235	355.0	280.0	SK15	NA	Horiz.	5,000	200/600 double insulated	faston	10	924584644917
15092Z	2,000	235	355.0	280.0	SK15	NA	Any	5,000	600/600 double insulated	splice	10	924586744916
11002Z	2,000	235	355.0	280.0	SK15	NA	Any	5,000	150/500 insulated	splice	10	924589744916
15114A	2,000	235	364.0	280.0	AK15	2,500	Any	5,000	160/510	splice	10	924594944916
11003A	2,000	235	364.0	280.0	AK15	2,500	Any	5,000	160/510	splice	10	924595444916
15118AK	2,000	235	375.0	280.0	AK15/31	2,500	Any	5,000	160/715	splice	10	924598244916
15120Z	2,000	235	532.0	444.0	SK15	2,450	Any	5,000	150/500	splice	10	924598544916

For custom solutions (base, watt, volt, applications...), please contact us.

Lucia™ lamps

The DR. FISCHER Lucia™ lamps are our best value products for Comfort Heating applications. Their unique and resistant coating spreads warm orange light in the room or on the terrace while providing users a comfortable heat. Our Lucia™ range is a perfect balance between performance and price.

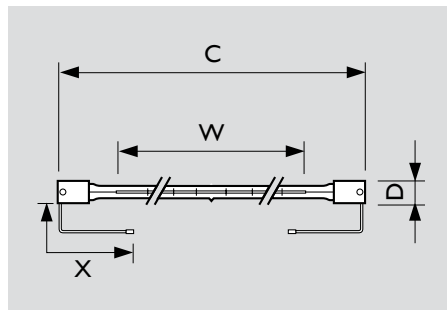
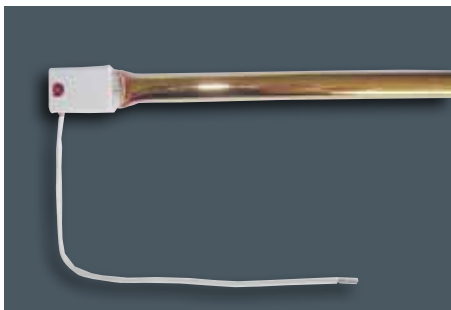

DR. FISCHER Lucia™ lamps short waves

Average lifetime	5,000 hours
Bulb diameter (D)	11 mm
Burning position	Horiz.

Type #	Watt	Volt	Total length mm (C)	Heating length mm (W)	Base	Colour temp. K	Cable (X)	Terminal	Qty box (pc)	Order #
63000Z	1,500	235	355.0	280.0	SK15	NA	600/600 double insulated	splice	10	please contact us
63001Z	2,000	235	355.0	280.0	SK15	NA	600/600 double insulated	splice	10	
63002Z	1,500	120	355.0	280.0	SK15	NA	600/600 double insulated	splice	10	

For custom solutions (base, watt, volt, applications...), please contact us.



Healthcare solutions



DR. FISCHER infrared halogen lamps for Healthcare

We live in a more and more urban and contaminated environment. Gas emissions from cars, factories, power stations etc. produce harmful substances. These toxins are collected by our body and eventually cause different kinds of symptoms. Sweating is one of the solutions to eliminate toxic absorptions and purify our body. DR. FISCHER Infrared lamps emit infrared

rays, that penetrate deep into the skin. The feeling of gentle warmth makes the body sweat and has relaxing and soothing effects. The physical relaxation enables the elimination of stress and anxiety. DR. FISCHER Vitae™ infrared halogen lamps are designed for creating well-being experiences when relaxing in wooden infrared cabins or saunas. These

highly technological lamps give health and beauty centers the opportunity to offer an innovative, fast and valuable service. DR. FISCHER Vitae™ infrared halogen lamps have numerous benefits for the body like a warm feeling with an efficient, direct and gentle heat.

Areas of use

Support	Residential, domestic private user	Hospitality, commercial customer
Infrared cabins & saunas	<ul style="list-style-type: none"> • Domestic light 	<ul style="list-style-type: none"> • Therapy centers • Fitness centers • Spas centers • Wellness • Babycare...

Overview of caps

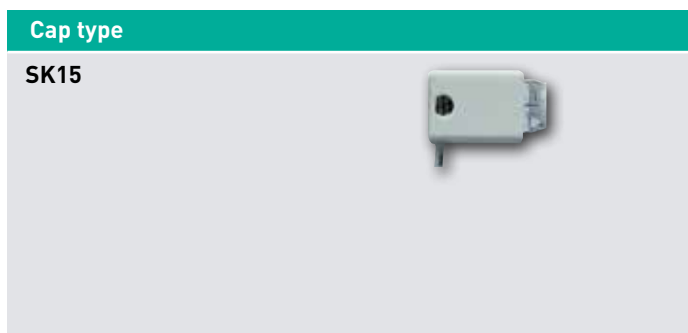

Overview of terminals

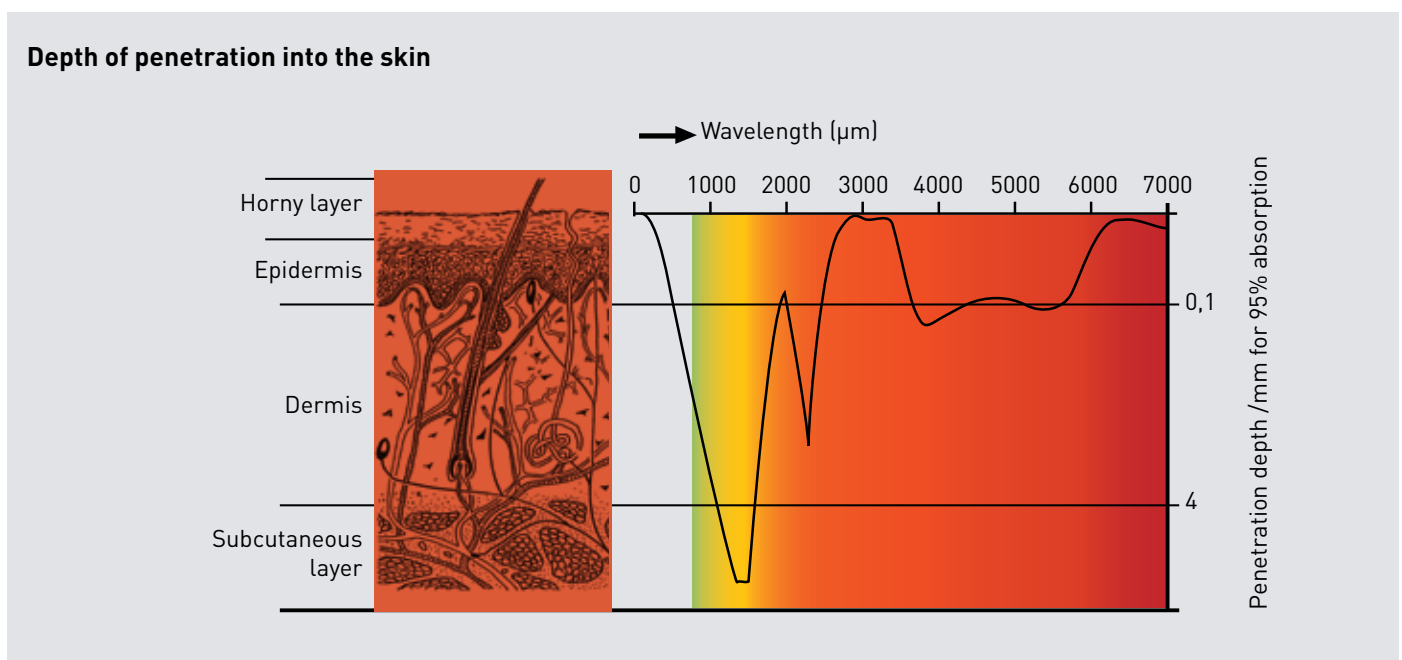
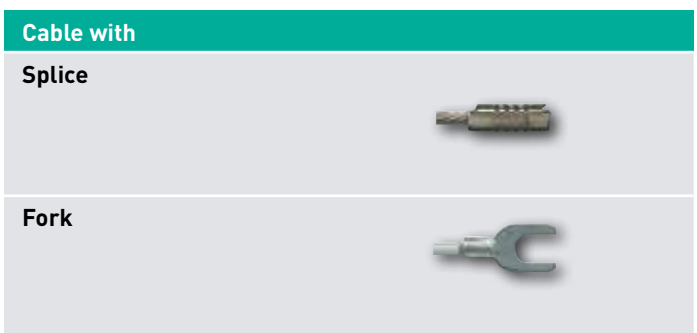

Vitae™ lamps

The DR. FISCHER Vitae™ lamps deliver the optimum balance across the infrared emission spectrum. The lamp emissions reach the subcutaneous layer of the skin (see graph: "Depth of penetration into the skin") where heat is dissipated more efficiently. This gives a more diffuse and pleasant warming effect.

The balance between short and medium infrared waves of Vitae™ lamps is therefore perfectly suitable for body heating, combining as it does the heat effect (skin penetration by short infrared) and heat feeling (given by medium infrared waves to warn against excess heat).

Because of their low colour temperature, DR. FISCHER Vitae™ lamps only emit little visible light, even without a coating. Our Vitae™ range provides a direct body heating, matching the characteristics of the skin.

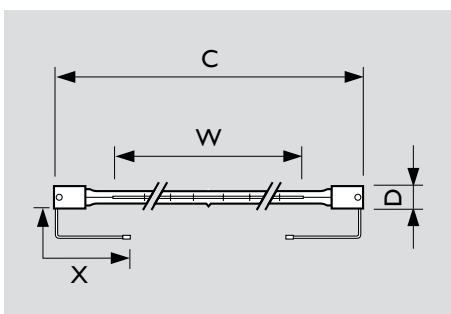
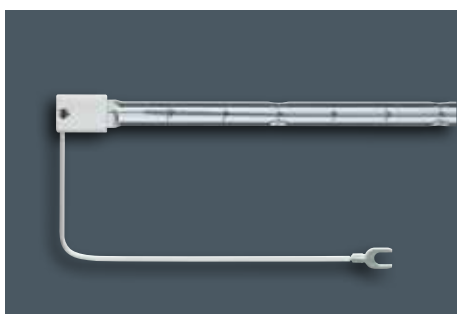

DR. FISCHER Vitae™ lamps medium waves

Average lifetime	5,000 hours
Bulb diameter (D)	11 mm

Type #	Watt	Volt	Total length mm (C)	Heating length mm (W)	Base	Colour temp. K	Burning position	Cable (X)	Terminal	Qty box (pc)	Order #
14181Z	300	120	433.0	380.0	SK15	1,850	Any	100/600 insulated	splice	10	924576136316
14169Z	350	235	628.0	550.0	SK15	1,750	Any	230/1200 insulated	splice	10	924570044916
14142Z	500	235	787.5	700.0	SK15	1,800	Any	230/1200 insulated	splice	10	924555644916
14157Z	500	235	628.5	550.0	SK15	1,800	Any	230/1200 insulated	splice	10	924562944916
14208Z	500	235	787.5	700.0	SK15	1,800	Any	230/1200 insulated	splice	10	924588744916
14117Z	750	230	787.0	700.0	SK15	2,000	Any	230/1200 insulated	splice	10	924540544216
14124Z	750	230	787.0	700.0	SK15	1,750	Any	230/1200 insulated	splice	10	924547944216
14155Z	750	230	787.0	700.0	SK15	1,750	Any	230/1200 insulated	splice	10	924562244216
13393Z	1,300	235	787.0	700.0	SK15	2,000	Any	200/200 insulated	fork	10	923945444516
13990Z	1,300	235	787.0	700.0	SK15	2,000	Any	230/1200 insulated	splice	10	924591644916

For custom solutions (base, watt, volt, applications...), please contact us.



Systems & Technical support



DR. FISCHER & You: an efficient partnership for improving your performance

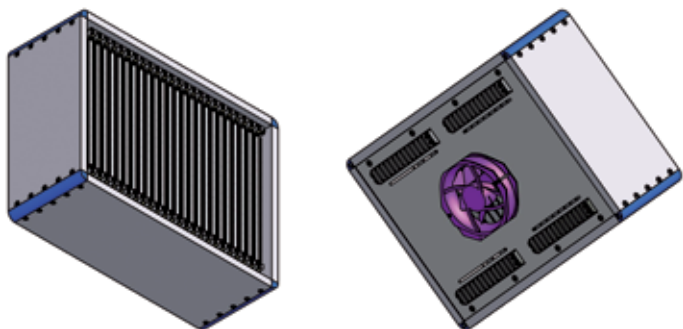

3D Representation of the module 48KW 24 lamps LRP™ module

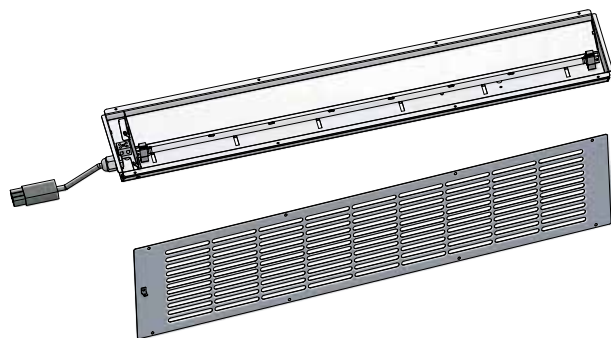

Module for infrared sauna cabin applications. Used with Vitae™ product range

We know that in our current industrialized world, energy cost is a key parameter for our customers. Costs have to be minimized while safety is mandatory. We, DR. FISCHER, want to be more than just a supplier of high-quality infrared halogen lamps. In specific industrial applications we can help you to decrease your energy consumption up to 40%.

We are committed to offering you a world class service in every aspect of our business. One of our key advantages is our innovative Research & Development Department. We not only design measurement units or lamps, but also improve existing systems and even offer our demanding customers completely new designed systems. DR. FISCHER will be your closest partner for Industrial and Comfort Heating applications.

At DR. FISCHER we are experts in improvements of current systems and we show customers 3D simulations of systems which can easily ("Plug&Play") be installed into their machines for increasing their performance.

In fact, on request, we can evaluate the performance of our customers' systems.

- DR. FISCHER in Pont-à-Mousson, France, is equipped with a unique Spatial Irradiance Measurement bench (XY bench). This enables us to evaluate and qualify the irradiance (heat output) of lamps, heaters and industrial infrared systems.

- Based on the needs of our demanding customers, we are able to provide advice on specific matters such as a reflector geometry optimization. The accuracy of the

results is given by the use of specific measurement control systems.

- Measurements are conducted in a dark room to eliminate any disturbances. Lamp voltage, fluxmeter and temperature are under constant control during measurements.

We, at DR. FISCHER, know that reducing time to market in the development of new systems is essential. The specific PH3D optical modeling software, based on an efficient 3D ray tracing method, is used to optimize our customers' high-performance infrared systems and solutions.

Using these tools, our infrared modeling support activities can address three main topics:

- Improvement or upgrading of existing reflectors or systems
- System configuration issues, such as lamp specifications and arrangement, installed power, sizing etc.
- Design of new reflectors to reach the defined heating specifications.

Our DR. FISCHER infrared modeling support allows our customers to predict system irradiance (heat output) by simulation without the need for any tooling or prototyping. This enables predictive, quantitative results to be achieved at a reasonable cost. The validity of modeling outputs is assured by regular calibration. Our infrared R&D team always provides accurate quotations for each project you have.

Customers working with us will decrease their time-to-market, increase their system's efficiency and lifetime.

For more information about our systems and technical support, please contact us!

www.dr-fischer-group.com



DR. FISCHER
Group

"Innovation drives our future"

The DR. FISCHER LRP™ Technology easily increases your system's performance

Irradiance at 20 cm operating distance

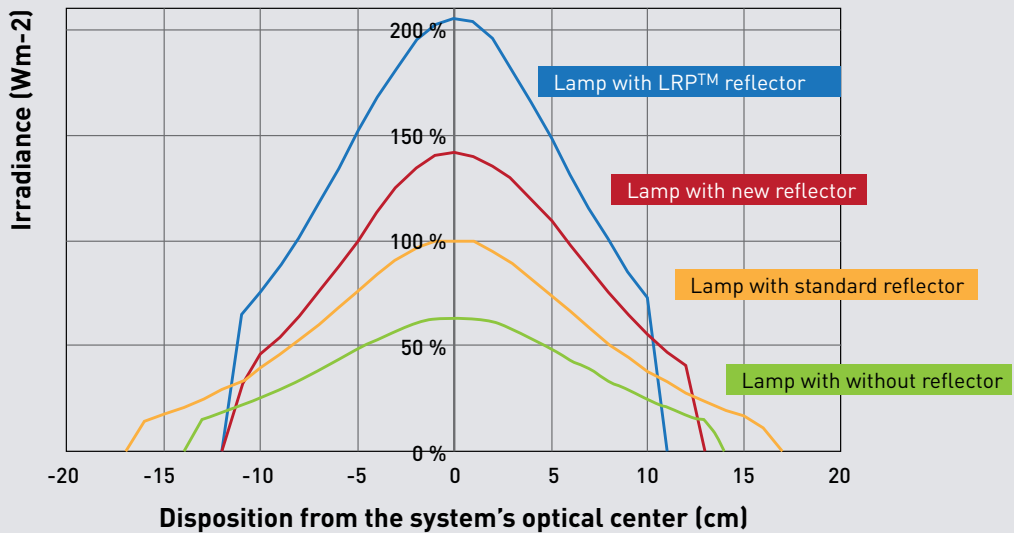

Infrared modeling support

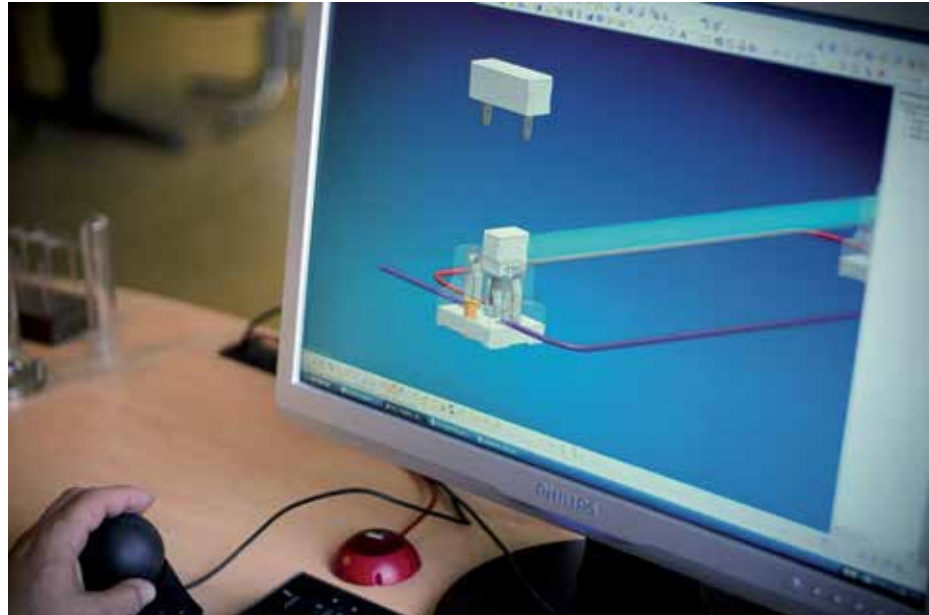
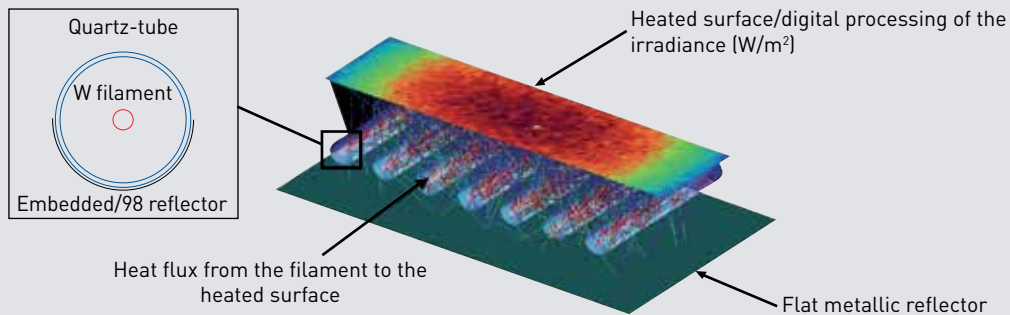

Range of accessories and customized solutions

When designing an infrared heater, it is very important to check that its performance matches expectations. To help OEMs assessing and optimizing the quality level of their heating system, the dedicated DR. FISCHER applications' team proposes specific measurements, modeling, design and a range of accessories.

Also, DR. FISCHER has the capability to provide complete solutions and new generation of systems in various technologies. Our expertise can support you and your business with highly customized solutions.

Type #	Terminal	Qty box (pc)	Order #
IRZ 500	Reflector IRZ	10	914510000112
IRZ 1000	Reflector IRZ	10	914510000212
IR3 236*98	Reflector IR3	10	914510000312
IR3 366*98	Reflector IR3	10	914510000412
6707	Holder metal	40	914510000510
7646	Holder ceramic	25	914510000615
Clip SK15	Clip SK15	100	914510000825
CF300SP	Holder ClicFit	20	914515000143
CF915SP	Holder ClicFit	20	914515000242
CF2000SP	Holder ClicFit	20	914515000343



Holder 6707



Clip SK 15



Holder 7646



Holder ClicFit

IR3 reflectors characteristics

All of our DR. FISCHER IR3 reflectors are made of anodized aluminum. They are extremely efficient parabolic reflectors for distances from 20 to 30 cm. Their orange peel surface structure smoothens the irradiance curve of the heat distribution. Their special design (shape and surface)

achieves the most homogeneous irradiance over the heated surface in combined reflector arrangements: multiple crosswise or staggered installation.

Applications

- Plastic thermoforming
- Textile industry: drying textile materials
- Floor covering: heat treatment of carpets and various floor covering

Technical data

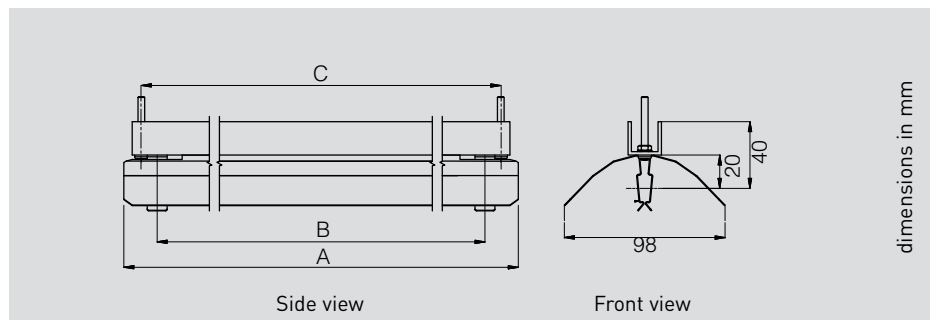
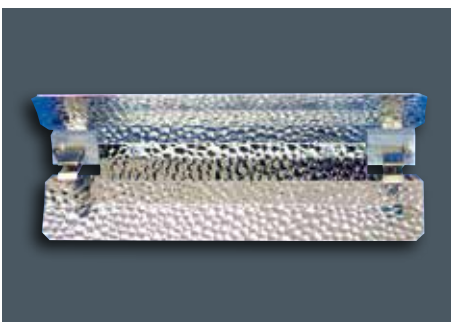

Reflector	A (mm)	B (mm)	C (mm)
IR3 236*98	236	196	215
IR3 366*98	366	326	345

The reflector IR3 236*98 is compatible with:

- AK15 base : total length of 238.0 mm
- SK15 base : total length of 227.0 mm

The reflector IR3 366*98 is compatible with lamps:

- AK15 base : total length from 366.0 to 375.0 mm
- SK15 base: total length of 355.0 mm

Irradiance distribution curve for one unit

Irradiance distribution at 10, 20 and 30 cm, crosswise and length wise for:

- Lamp 1000 W 13402Z (left)
- Lamp 500 W 15011Z (right)

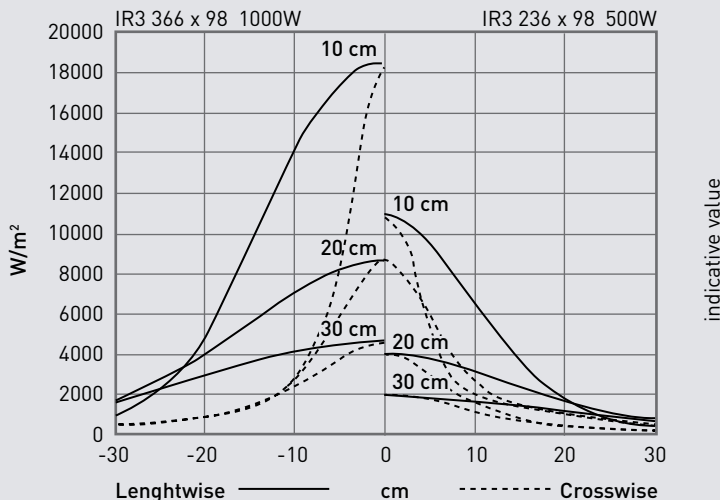

IRZ reflectors characteristics

Our DR. FISCHER IRZ aluminum reflectors are suitable for one quartz infrared halogen lamp. They offer a good uniformity of the infrared radiation on short distances (about 20 cm). The small dimension of the reflector enables high power densities

when installed in combination with a lamp (see calculations). To optimize the radiation output, we advise our customers to use lamps with white reflector (.../98) or (.../83).

Applications

- Catering: food grilling and fast food industry, food warming
- Various industrial processes

Technical data

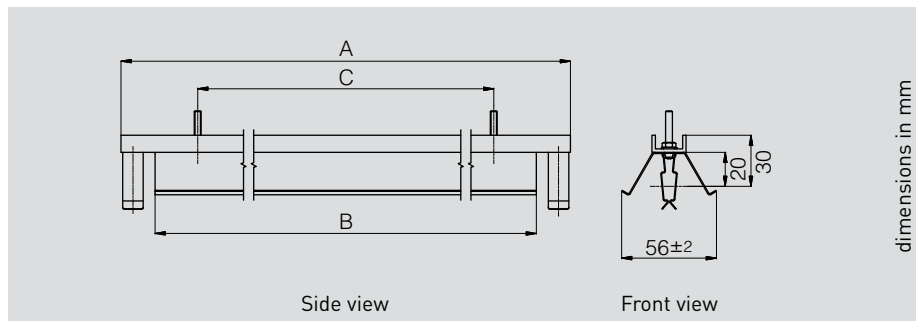

Reflector	A (mm)	B (mm)	C (mm)
IRZ 500	230	170	120
IRZ 1000	360	300	250

The reflector IRZ 500 is compatible with :

- AK15 base : total length of 238.0 mm
- SK15 base : total length of 227.0 mm

The reflector IRZ 1000 is compatible with lamps:

- AK15 base : total length from 366.0 to 375.0 mm
- SK15 base: total length of 355.0 mm

Irradiance distribution curve for one unit

Irradiance distribution at 10, 20 and 30 cm, crosswise and length wise for:

- Lamp 1000 W 13402Z (left)
- Lamp 500 W 15011Z (right)

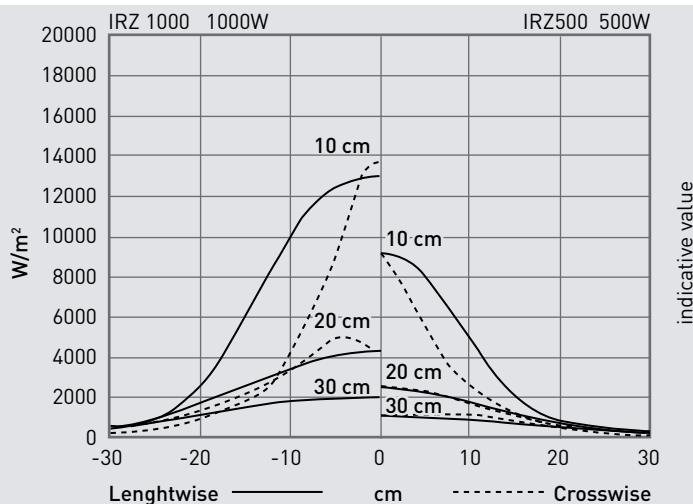

Pictograms description



Preferably do not touch quartz with bare hands. If grease or chemical compound has been deposited on quartz, simply clean with an alcohol-soaked tissue before lighting.

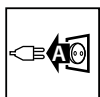

Disconnect installation from power supply before removing or installing a lamp.

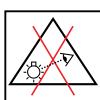

Prolonged looking at the lamp during operation may result in damage to the eye.



Keep dry.



Weatherproof.



Non Household.

Integration rules

Standard permissible temperatures

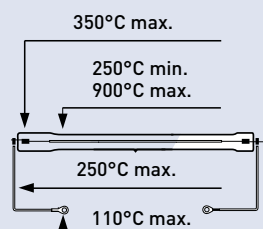

DR. FISCHER infrared halogen lamps with HeLeN™ technology permissible temperatures

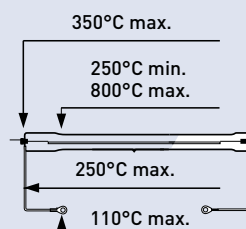

Recommendations

» To avoid pinch damages:

pinch temperature has to be below 350°C /662°F

» To ensure a proper halogen cycle:

tube temperature has to be higher than 250°C /482°F

» To avoid tube damages:

tube temperature has to be lower than 900°C /1652°F and lower than 800°C /1472°F for HeLeN™, Garneta™ and Lucia™

Our Pont-à-Mousson manufactured infrared lamps are compliant with applicable norms and legislation such as :

- Directive 2006/25/EC of the European Parliament and of the council of 5 April 2006 on the minimum health and safety requirements regarding the exposure of workers to risks arising from physical agents (artificial optical radiation).
- Norm IEC62471 : 2008 : Photobiological Safety of Lamp Systems

CAUTION:

In all shipped boxes of products, we also provide a list of precautions for using our quartz infrared halogen lamps with a maximum safety.

- 1 Disconnect installation from power supply before removing or installing a lamp.
- 2 Preferably do not touch quartz with bare hands. If grease or chemical compound has been deposited on quartz, simply clean with an alcohol-soaked tissue before lighting.
- 3 Prolonged looking at the lamp during operation may result in damaging the eye.
- 4 Take care not to exceed permissible pinch temperature as indicated in the

technical notice.

- 5 Respect burning position of the lamp as indicated in the technical documentation.
- 6 Avoid over-voltage, as this can adversely affect the lifetime of the lamp.
- 7 Integrate lamp in an equipment specifically designed for the type and the rating of that lamp.
- 8 Use fuse in conformity with the type and rating of the lamp.
- 9 Protect the lamp against shocks and vibrations even when that lamp is cold.
- 10 To ensure the warranted lifetime of our lamps, protect them against contaminants' projections like salt, ammonia gas, cement dust...

Do not re-use a weatherproof HeLeN™ lamp after having removed it from a heating module.

Non-observance of these precautions may lead to damage lamps and systems. In extreme cases, it can even create unsafe situations.

As manufacturer, DR. FISCHER cannot assume any liability for personal injury or damage to equipment that may result from improper use of the lamp or using inappropriate equipment.

Conflict Minerals Certificate

By signing this certificate, we declare that we will fulfill those below points :

- Had determine which of our products/ components contain tin, tungsten, tantalum or gold,
- Had map our supply chains associated with those products/ components,
- Engage with our suppliers to identify all the smelters our company and suppliers use to supply the tin, tantalum, tungsten and/ or gold,
- Confirm that no any of our supplier use conflict minerals products in their production used by us even partly.

notes

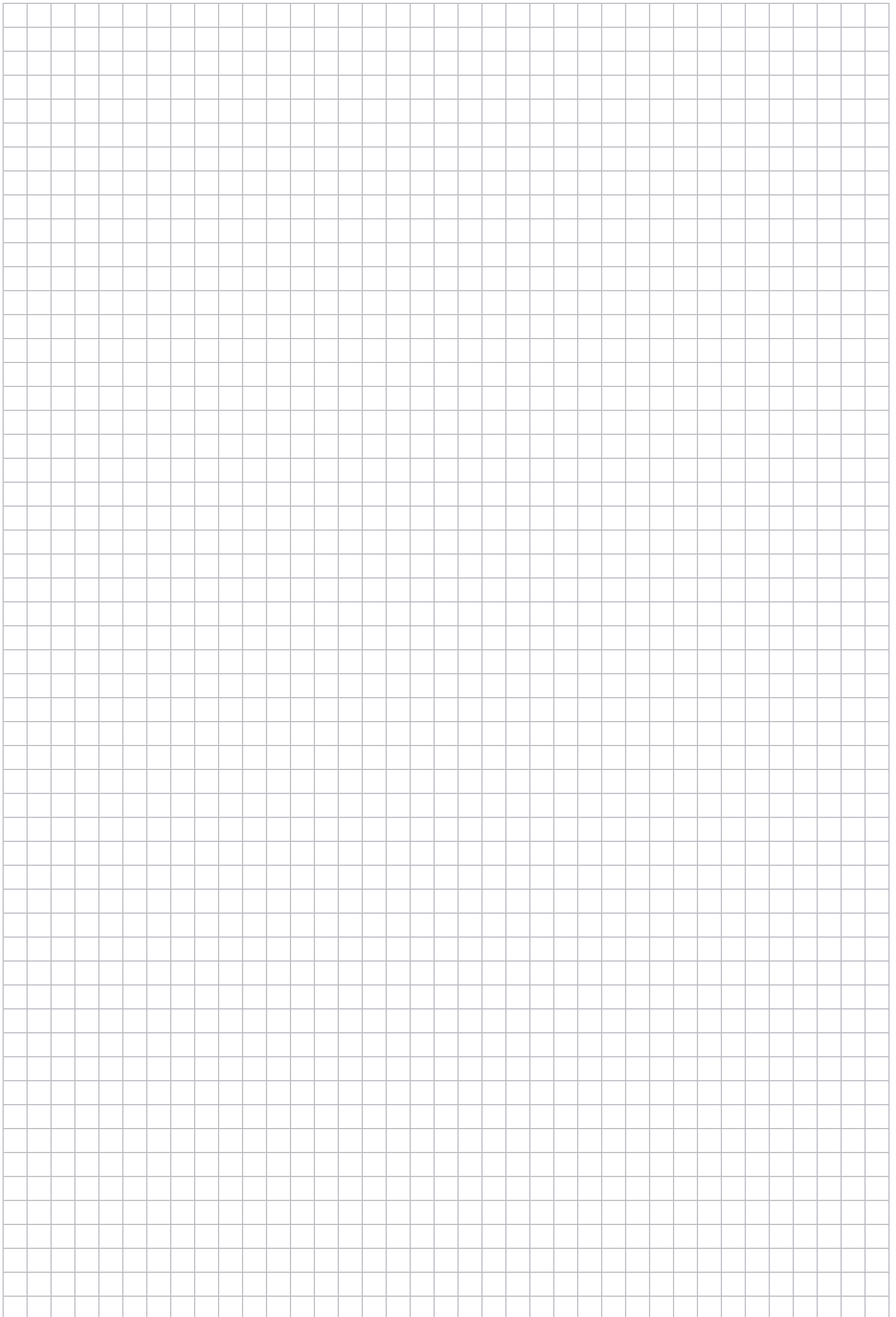

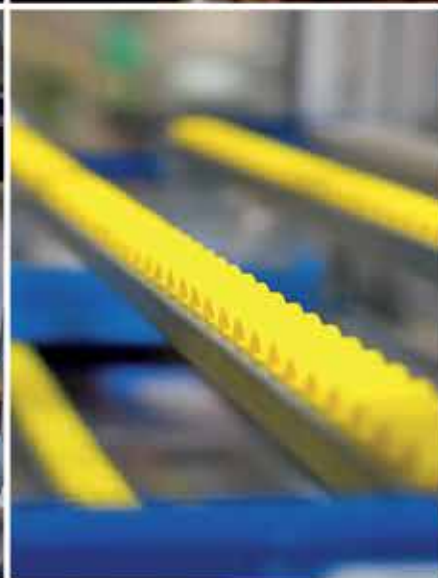
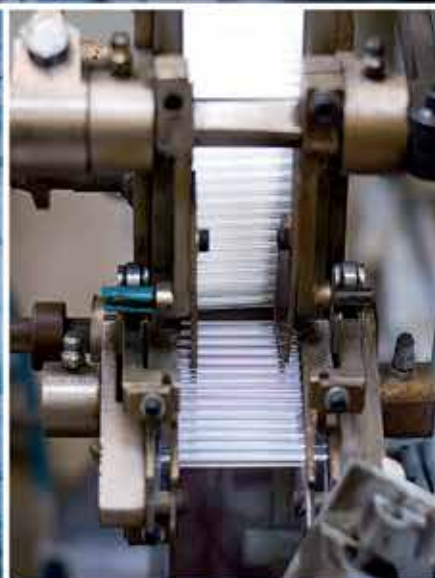

Contacts



DR. FISCHER
Group

Nikolaus-Otto-Straße
65582 Diez / Lahn
DEUTSCHLAND
Tel: +49 (0) 64 32 / 91 31- 0
Fax: +49 (0) 64 32 / 6 20 69
Internet: www.dr-fischer-group.com
Email: info@dr-fischer-group.com



DR. FISCHER
Europe S.A.S

Zone industrielle de Montrichard
BP 80149
54705 Pont-à-Mousson CEDEX
FRANCE
Tel: +33 (0) 3 83 80 30 60
Fax: +33 (0) 3 83 80 30 48
Internet: www.dr-fischer-group.com
Email: info.europe@dr-fischer-group.com



Lumin
SPECIAL LIGHTING

Sales partner Lumin Special Lighting BV Dorpstraat 6-A6261 JN Mheer